



**17"[16:9] AV/TV/PC MONITOR
MULTI-COLOR SYSTEM TV TUNER**

DTV-171

Operation Manual



<http://www.initialdvd.com>

Please read carefully before use.

TABLE OF CONTENTS (FOR TV TUNER)

IMPORTANT INFORMATION	1
IMPORTANT SAFETY PRECAUTIONS	2-3
SUPPLIED ACCESSORIES	4
PREPARATION	5
• INSERTING BATTERIES INTO THE REMOTE CONTROL	5
• USING THE REMOTE CONTROL UNIT	5
• CAUTIONS REGARDING REMOTE CONTROL UNIT	5
FUNCTIONAL OVERVIEW	6-9
• FRONT VIEW	6
• REAR VIEW	7
• REMOTE CONTROL	8-9
CONNECTIONS	10-11
• MAIN CONNECTION	10
• ANTENNA CONNECTION	10
• CONNECTING EXTERNAL EQUIPMENT	11
BASIC OPERATIONS	12
• TURNING ON THE POWER	12
• TURNING OFF THE POWER	12
• TV/AV MODE SELECTION	12
WATCHING TV	13-15
• TURNING ON THE POWER	13
• TURNING OFF THE POWER	13
• SIMPLE BUTTON OPERATIONS FOR CHANGING CHANNELS	13
• USING LAST ON THE REMOTE UNIT	14
• SIMPLE BUTTON OPERATION FOR CHANGING VOLUME/SOUND	15
MENU ADJUSTMENT	16-24
• CHANNEL ADJUSTMENT	16-17
• PICTURE ADJUSTMENT	18
• AUDIO ADJUSTMENT	19-20
• WINDOW ADJUSTMENT	21-23
• OPTIONS ADJUSTMENT	24
TROUBLESHOOTING	25
SPECIFICATIONS	26

IMPORTANT INFORMATION

WARNING: TO REDUCE THE RISK OF FIRE OR ELECTRIC SHOCK, DO NOT EXPOSE THIS PRODUCT TO RAIN OR MOISTURE.

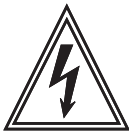
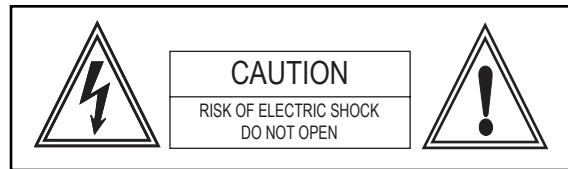

The lightning flash with arrowhead symbol, within an equilateral triangle, is intended to alert the user to the presence of uninsulated "dangerous voltage" within the product's enclosure that may be of sufficient magnitude to constitute a risk of electric shock to persons.



The exclamation point within a triangle is intended to alert the user to the presence of important operation and maintenance (servicing) instructions in the literature accompanying the product.

FCC RF INTERFERENCE STATEMENT

NOTE: This equipment has been tested and found to comply with the limit for a Class B digital device, pursuant to Part 15 of the FCC Rules. These limits are designed to provide reasonable protection against harmful interference in a residential installation.

This equipment generates, uses and can radiate radio frequency energy and, if not installed and used in accordance with the instructions, may cause harmful interference to radio communications. However, there is no guarantee that interference will not occur in a particular installation.

If this equipment does not cause harmful interference to radio or television reception which can be determined by turning the equipment off and on, the user is encourage to try to correct the interference by one or more of the following measure.

- Reorient or relocate the receiving antenna.
- Increase the separation between the equipment and receiver.
- Correct the equipment into an outlet on a circuit different from that to which the receiver is connected.
- Consult the dealer or an experienced radio, TV technical for help.
- Only shielded interface cable should be used.

IMPORTANT SAFETY PRECAUTIONS

The present set has been designed and manufactured to assure personal safety. Improper use can result in electric shock or fire hazard. The safeguards incorporated in the present unit will protect you if you observe the following procedures in installing, using and servicing. The present unit is fully transistorized and does not contain any element that can be repaired by the user.

1. Read these instructions - All operating instructions must be read and understood before the product is operated.
2. Keep these instructions - These safety and operating instructions must be kept in a safe place for future reference.
3. Heed all warnings - All warnings on the product and in the instructions must be observed closely.
4. Follow instructions - All operating instructions must be followed.
5. Attachment - Do not use attachments not recommended by the manufacturer. Use of inadequate attachments can result in accidents.
6. Power source - This product must operate on a power source specified on the model label. If you are not sure of the type of power supply used in your home, consult your dealer or local power company.
7. AC cord protection - The AC cords must be routed properly to prevent people from stepping on them or objects from resting on them. Check the cords at the plugs and product.
8. Overloading - Do not overload AC outlets or extension cords. Overloading can cause fire or electric shock.
9. Entering of objects and liquids - Never insert an object into the product through vents or openings. High voltage flows in the product, and inserting an object can cause electric shock and/or short internal parts. For the same reason, do not spill water or liquid on the product.
10. Servicing - Do not attempt to service the product yourself. Removing covers can expose you to high voltage and other dangerous conditions. Request a qualified service person to perform servicing.
11. Repair - If any of the following conditions occurs, unplug the AC cord from the AC outlet, and request a qualified service person to perform repairs.
 - a) When the AC cord or plug is damaged.
 - b) When a liquid was spilled on the product or when objects have fallen into the product.
 - c) When the product has been exposed to rain or water.
 - d) When the product does not operate properly as described in the operating instructions. Do not touch the controls other than those described in the operating instructions. Improper adjustment of controls not described in the instructions can cause damage, which often requires extensive adjustment work by a qualified technician.
 - e) When the product has been dropped or damaged.

IMPORTANT SAFETY PRECAUTIONS

- f) When the product displays an abnormal condition. Any noticeable abnormality in the product indicates that the product needs servicing.
12. Replacement parts - In case the product needs replacement parts, make sure that the service person uses replacement parts specified by the manufacturer, or those with the same characteristics and performance as the original parts. Use of unauthorized parts can result in fire, electric shock and/or other danger.
 13. Safety checks - Upon completion of service or repair work, request the service technician to perform safety checks to ensure that the product is in proper operating condition.
 14. Wall or ceiling mounting - When mounting the product on a wall or ceiling, be sure to install the product according to the method recommended by the manufacturer.
 15. Unplug the AC cord from the AC outlet before installing the speakers.
 16. Cleaning - Unplug the AC cord from the AC outlet before cleaning the product. Use only with a dry cloth to clean this apparatus. Do not use liquid or aerosol cleaners.
 17. Water and moisture - Do not use this product near water such as bathtub, washbasin, kitchen sink and laundry tub, swimming pool and in a wet basement. TV set shall not be exposed to dripping or slashing and no objects filled with liquid, such as vases, shall be placed on the TV set.
 18. Stand - Do not place the product on an unstable cart, stand, tripod or table. Unstable installation is likely to make the product fall resulting in serious injuries as well as material damage. Use only the cart, stand, tripod, bracket, or table specified by the manufacturer, or sold with the apparatus.
 19. When a cart is used, use caution when moving the cart/apparatus combination to void injury from tip-over.
 20. Ventilation - The vents and other openings in the cabinet are designed for ventilation. Do not cover or block them since insufficient ventilation can overheat and/or shorten the product's life span. Do not place the product on the bed, sofa, rug or other similar surfaces since they can block ventilation openings. This product is not designed for built-in installation; do not place the product in an enclosed place such as a bookcase or rack unless proper ventilation is provided or the manufacturer's instructions are followed.
 21. The LCD panel used in this product is made of glass. Therefore, it can be broken when the product is dropped or gets shock. Be careful not to be injured by glass pieces in case the panel is broken.
 22. Heat sources - Do not install near any heat sources such as radiators, heat registers, stoves, or other apparatus (including amplifiers) that produce heat.
 23. The LCD panel is a product of very high technology with 2,949,120 thin film transistors, giving you fine picture details. Occasionally, a few non-active pixels may appear on the screen as a fixed blue, green or red point. Please note that this does not affect your product's performance.

SUPPLIED ACCESSORIES

Make sure the following accessories are provided with the product.



Power adapter



AV cable



Remote control

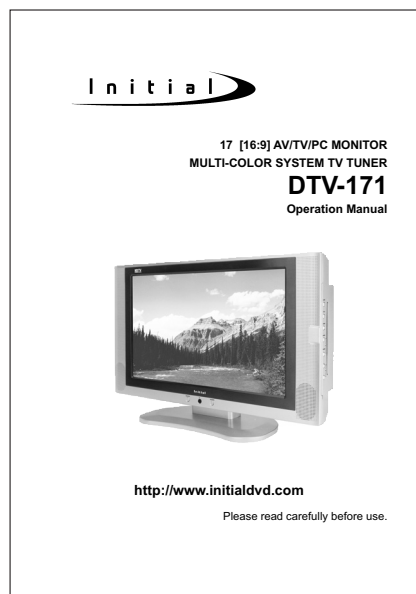

User guide

PREPARATION

INSERTING BATTERIES INTO THE REMOTE CONTROL

Insert supplied batteries via the battery compartment on the back of the remote control. Make sure polarity matches the (+) and (-) marks inside the compartment.

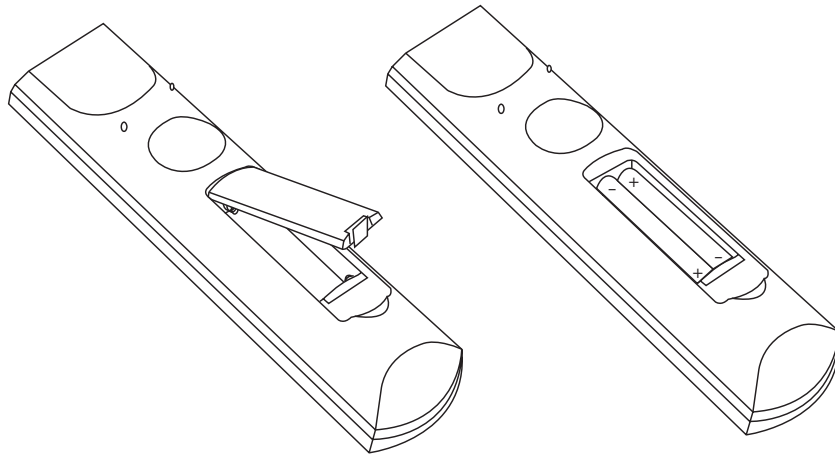

USING THE REMOTE CONTROL UNIT

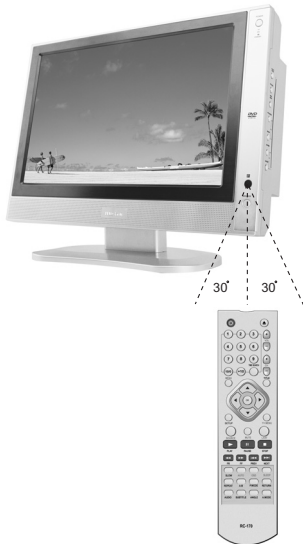

- Use the remote control by pointing it towards the remote sensor on the TV. Objects between the remote control and the sensor may disrupt operation.
- Effective range is 20 feet but is dependant on what your viewing angle is.
- Range can also be affected by direct sunlight on the TV's sensor.

CAUTIONS REGARDING REMOTE CONTROL UNIT

- Do not expose remote to liquids, direct sunlight or shock.
- The remote control unit may not work properly if the remote sensor window of the Display is under direct sunlight or strong lighting. In such case, change the angle of the lighting or Display, or operate the remote control unit closer to the remote sensor window.

FUNCTIONAL OVERVIEW

FRONT VIEW

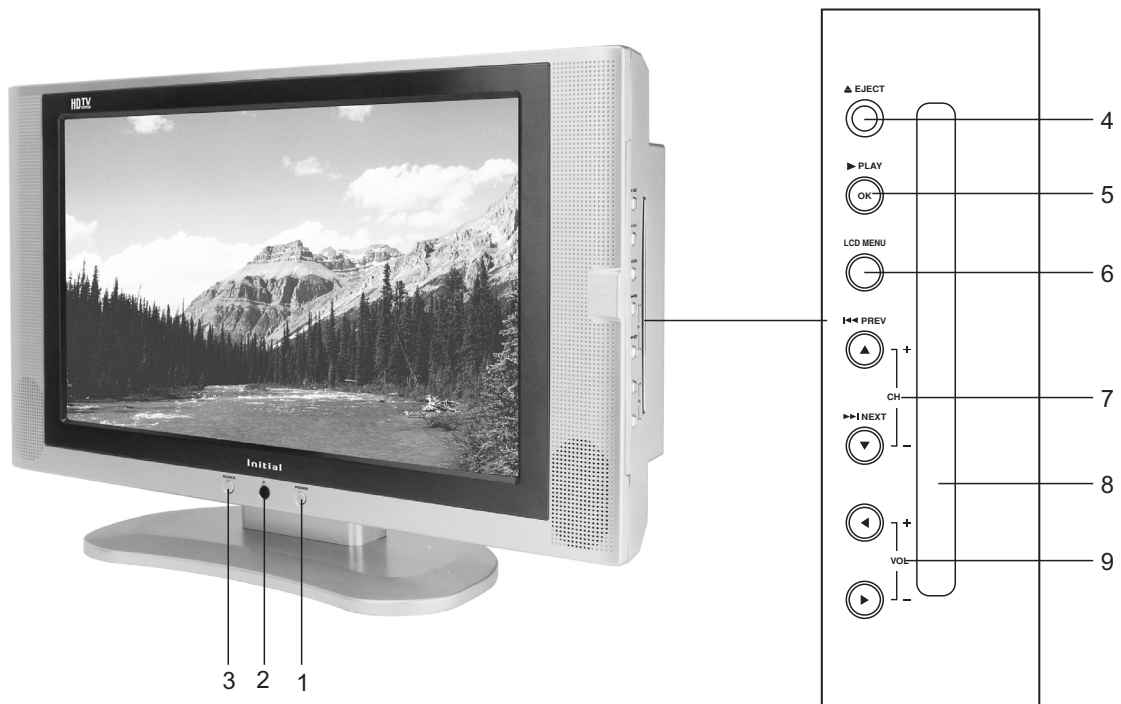

- 1) POWER BUTTON: Use to turn the unit on and off.
- 2) REMOTE SENSOR
- 3) SOURCE BUTTON: Use to select the AV signal source between: DVD, Analog RGB (PC input), Composite Video, S-Video, TV, Component Video, and use the **OK** button to confirm.
- 4) EJECT BUTTON: Use to eject the disc being played in the disc slot.
- 5) PLAY BUTTON: Use to begin the DVD playback.
- 6) LCD MENU: Use to bring up the LCD adjustment menu; use the cursor buttons to select an item and use the left or right button to adjust it.
- 7) PREV/NEXT (CH+/-): To skip to the previous/next chapter (previous/next channel).
- 8) DISC SLOT: Insert a DVD or CD disc to play under DVD status.
- 9) VOLUME+/-: Use to adjust the volume.

FUNCTIONAL OVERVIEW

REAR VIEW

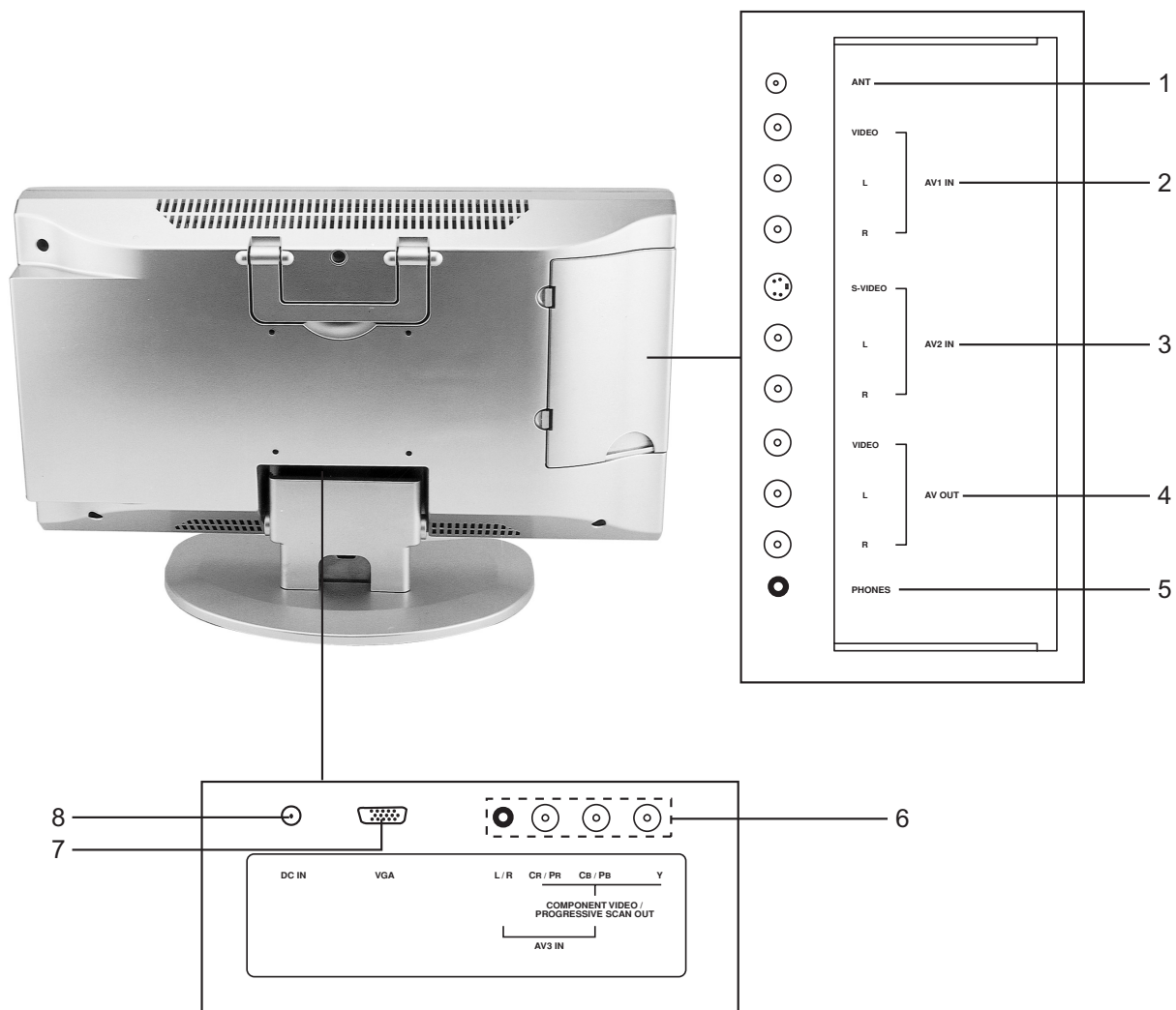

- 1) ANTENNA IN
- 2) AV1 IN (Composite Video and Audio In)
- 3) AV2 IN (S-Video and Audio In)
- 4) AV OUT (Composite Video and Audio Out)
- 5) PHONES
- 6) AV3 IN (Component Video and Audio In)
- 7) VGA (PC Input)
- 8) DC IN

FUNCTIONAL OVERVIEW

REMOTE CONTROL

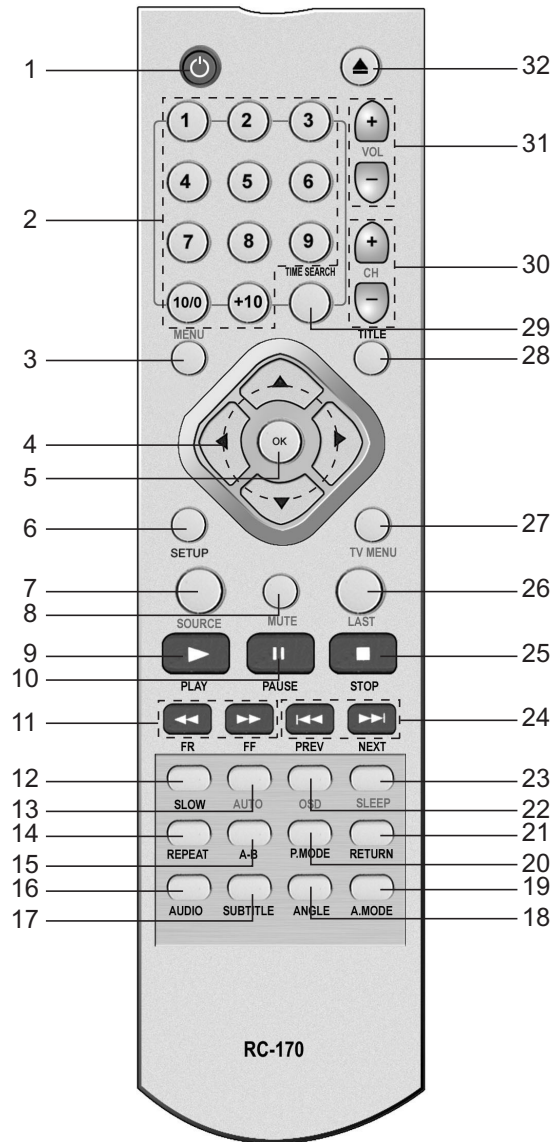

- 1) POWER: Use to turn the unit on and off.
- 2) Number Buttons: Use to set the channel and to enter DVD chapter numbers.
- 3) MENU: Use to bring up the DVD root menu.
- 4) Cursor Buttons: Use to select what you want.
- 5) OK: Use to confirm your selections.
- 6) SETUP: Use to bring up DVD setup menu.
- 7) SOURCE: Use to bring up the AV signal source selection screen and use the▲ / ▼buttons to select between: DVD, Analog RGB (PC input), Composite Video, S-Video, TV, Component Video, and press the **OK** button to confirm.

FUNCTIONAL OVERVIEW

REMOTE CONTROL (CONTINUED)

- 8) MUTE: Mute the sound.
- 9) PLAY: Use to begin the DVD playback.
- 10) PAUSE: Use to pause the DVD playback.
- 11) FF/FR: Use to play DVD fast forward/backward.
- 12) SLOW: Use to slow the DVD playback speed.
- 13) AUTO: Auto adjustment for PC signals.
- 14) REPEAT: Use to repeat the DVD playback.
- 15) A-B: Use to repeat play some part of DVD by setting begin point and ending point.
- 16) AUDIO: Use to shift DVD audio language.
- 17) SUBTITLE: Use to shift DVD subtitle language.
- 18) ANGLE: Use to shift DVD viewing angle.
- 19) A. MODE: Use to shift the DVD playback audio mode.
- 20) P. MODE: Use to shift DVD play mode.
- 21) RETURN: Return to the previous menu screen.
- 22) OSD: Use to bring up the DVD On-Screen-Display.
- 23) SLEEP: Set the sleep timer.
- 24) PREV/NEXT: Use to skip to the previous/next chapter.
- 25) STOP: Use to stop the DVD playback.
- 26) LAST: Press to return to the previous channel in normal viewing mode.
- 27) TV MENU: Use to bring up TV menu.
- 28) TITLE: Use to bring up the DVD title menu.
- 29) TIME SEARCH: Use to go to a special point of DVD by entering time number.
- 30) CH+/-: Use to skip to the previous/next channel.
- 31) VOLUME+/-: Use to adjust the volume.
- 32) EJECT(▲): Use to eject the disc being played in the disc slot.

CONNECTIONS

MAIN CONNECTION

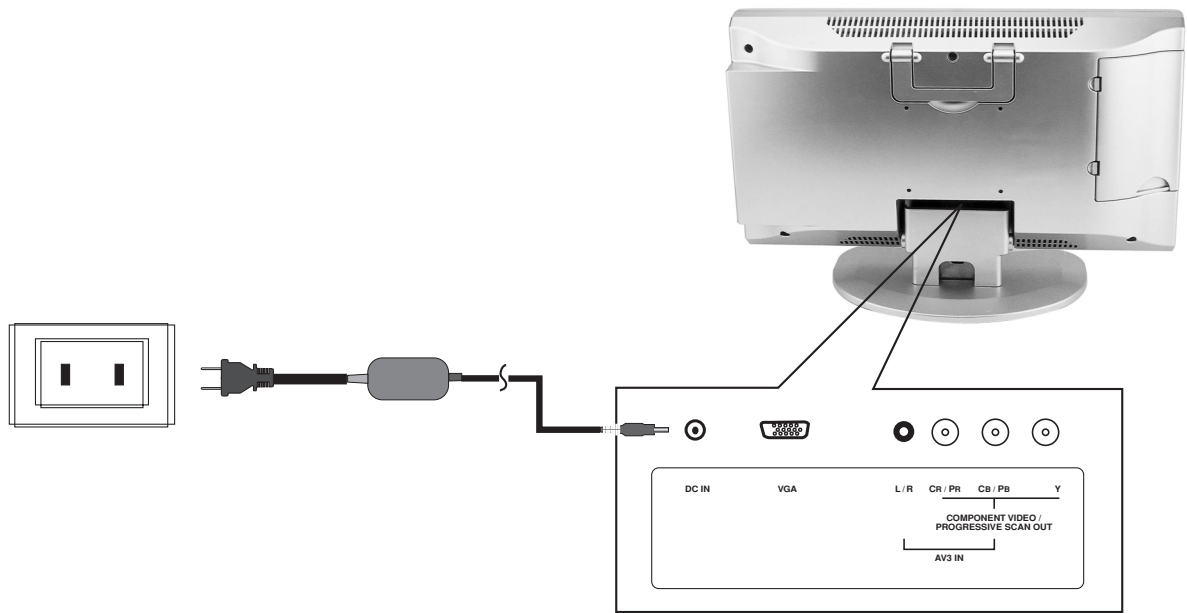

Plug the mains cable into the power socket with AC100V~240V, 50/60Hz.

ANTENNA CONNECTION

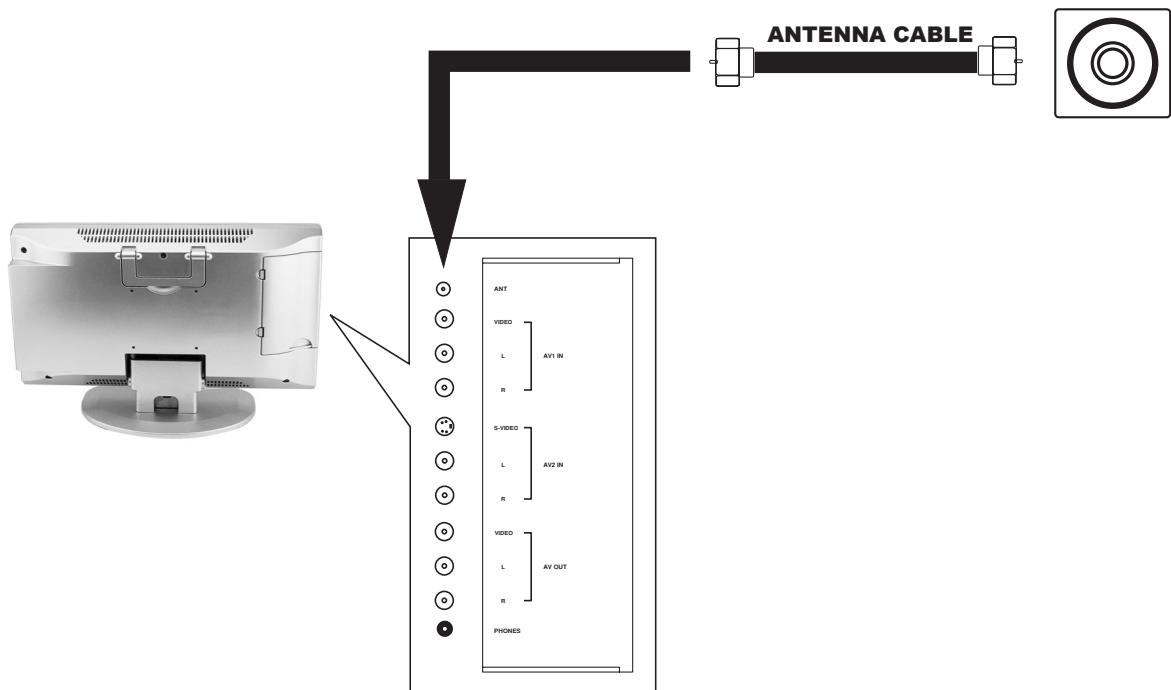

Using the supplied antenna cable, connect the room antenna terminal to the antenna input terminal on TV set.

CONNECTIONS

CONNECTING EXTERNAL EQUIPMENT

You can enjoy picture and sound by connecting VCR, DVD player and PC to the terminals located on the back of TV set.

Before connecting an external device, turn the TV set off to avoid any possible damage.

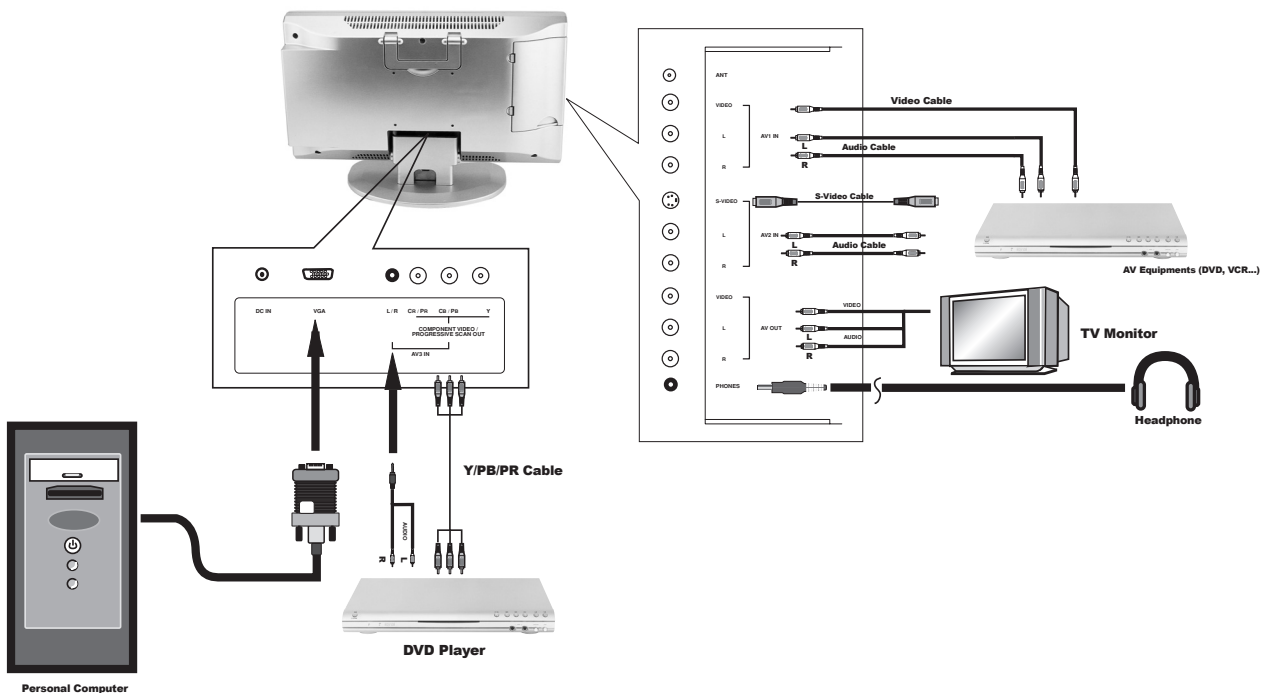

1. Connect a PC computer to the LCD through the VGA socket, press the **SOURCE** button on the remote to bring up Source selection screen, use the **▲/▼** buttons to select "PC" and press the **OK** button to confirm.
2. Connect AV equipment to the LCD through the AV1 IN jacks (Composite Video and Audio In jacks), press the **SOURCE** button on the remote to bring up Source selection screen, use the **▲/▼** buttons to select "Composite Video" and press the **OK** button to confirm.
3. Connect AV equipment to the LCD through the AV2 IN jacks (S-Video and Audio In jacks), press the **SOURCE** button on the remote to bring up Source selection screen, use the **▲/▼** buttons to select "S-Video" and press the **OK** button to confirm.
4. Connect AV equipment to the LCD through the AV3 IN jacks (Component Video and Audio In jacks), press the **SOURCE** button on the remote to bring up Source selection screen, use the **▲/▼** buttons to select "Component Video" and press the **OK** button to confirm.

BASIC OPERATIONS

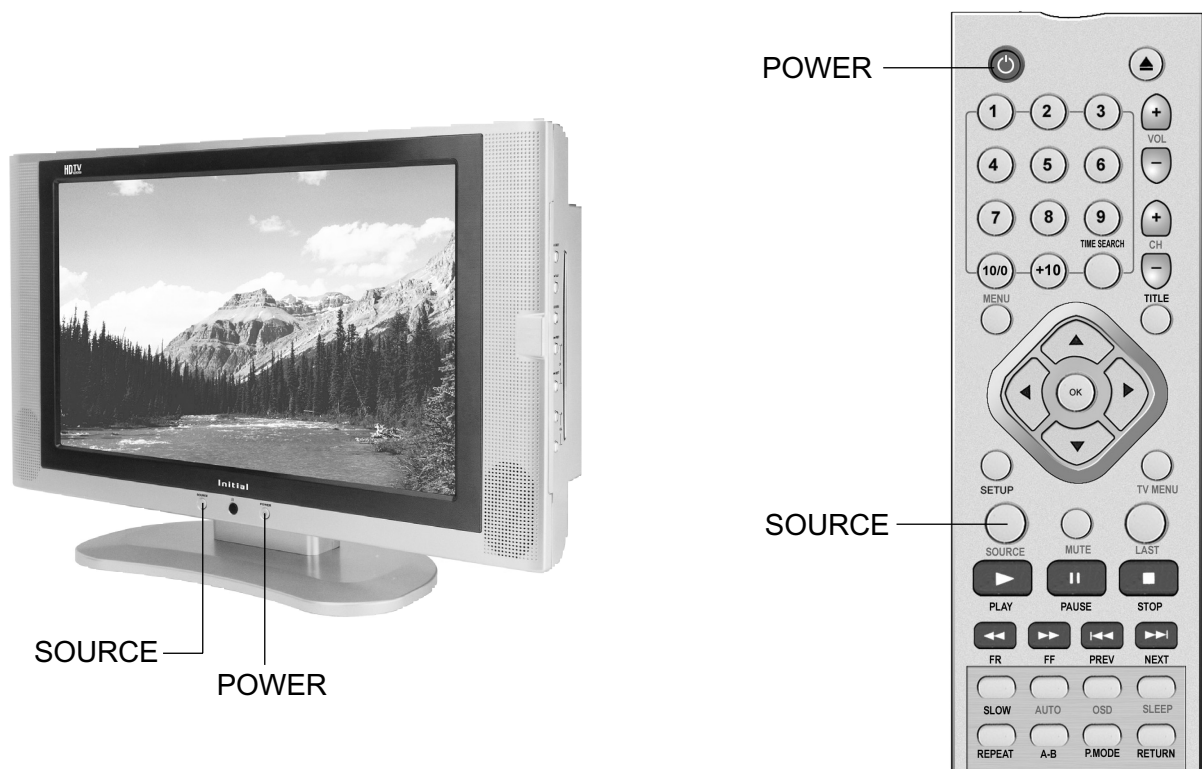

TURNING ON THE POWER

1. Press **POWER** button on the front panel to turn on the TV set. The STANDBY/ON indicator lights up green.
2. If the STANDBY/ON indicator still lights up red, press **POWER** on the remote control to turn the TV set on.

TURNING OFF THE POWER

1. Press **POWER** on the remote control, the image on the screen disappears and the STANDBY/ON indicator changes from green to red.
2. Press the **POWER** button on the front panel to turn the TV set off.

NOTE: Weak electric power is still consumed even when the power is turned off.

TV/AV MODE SELECTION

By pressing the **SOURCE** on the TV set and confirming by the **OK** button, you can change the mode as follows:

DVD → Analog RGB (PC input) → Composite Video → S-Video → TV → Component Video → ...

WATCHING TV

TURNING ON THE POWER

1. Press **POWER** button on the front panel to turn on the TV set. The STANDBY/ON indicator lights up green.
2. If the STANDBY/ON indicator still lights up red, press **POWER** on the remote control to turn the TV set on.

TURNING OFF THE POWER

1. Press **POWER** on the remote control, the image on the screen disappears and the STANDBY/ON indicator changes from green to red.
2. Press the **POWER** button on the front panel to turn the TV set off.

NOTE: Weak electric power is still consumed even when the power is turned off.

SIMPLE BUTTON OPERATIONS FOR CHANGING CHANNELS

You can change channels in several ways.

Using CH+/- on the remote unit

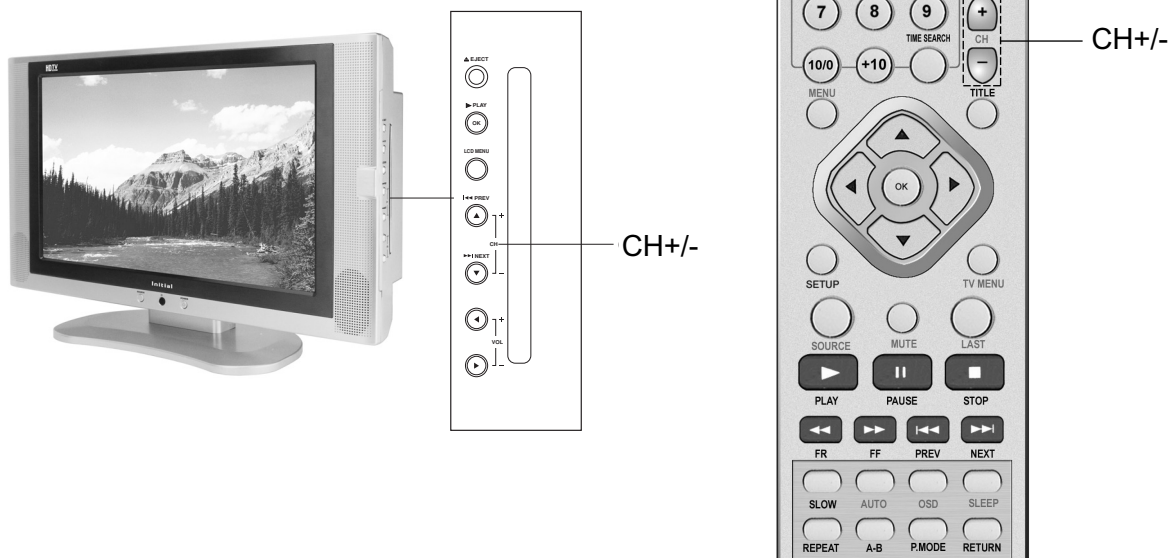

1. Press **CH+** to increase channel number.
2. Press **CH-** to decrease channel number.

NOTE: **CH+/-** on the TV set operates the same as **CH+/-** on the remote unit.

WATCHING TV

Using number buttons on the remote unit

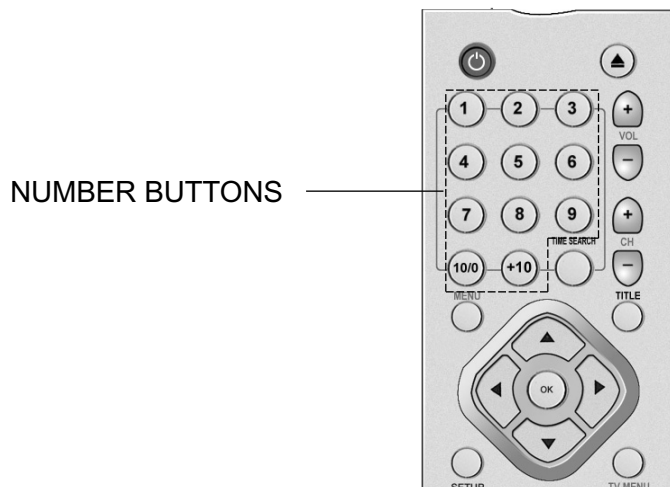

Select the channels directly by pressing the number buttons.

EXAMPLE:

To select a 1-digit channel (e.g. channel 2):

- Press **2**.

To select a 2-digit channel (e.g. channel 12):

- Press **1**, followed by **2**.

USING LAST ON THE REMOTE UNIT

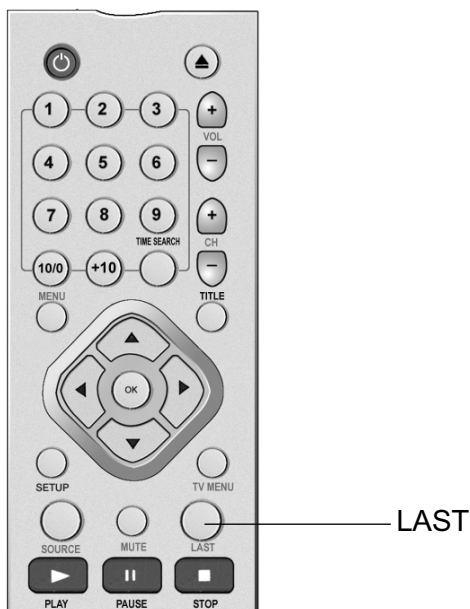

Press **LAST** to switch the currently tuned channel to the previous tuned channel.

Press **LAST** again to switch back to the currently tuned channel.

WATCHING TV

SIMPLE BUTTON OPERATION FOR CHANGING VOLUME/SOUND

Changing the volume

You can change the volume on the front panel or on the remote control unit.

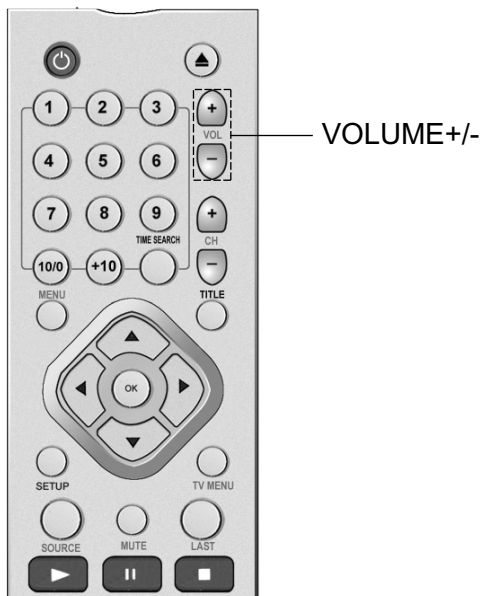

1. Press **VOL+** to increase the volume.
2. Press **VOL-** to decrease the volume.

Using MUTE on the remote control

Press **MUTE** to mute the current sound output.

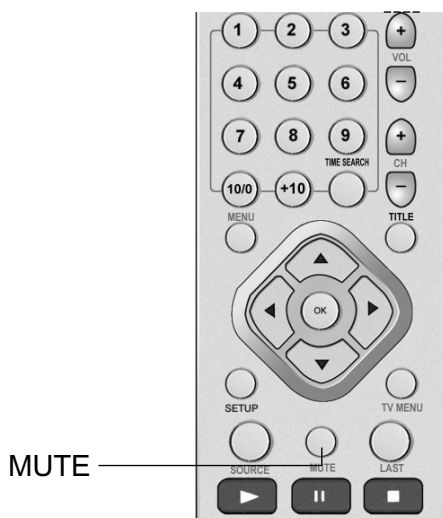

1. Press **MUTE** . "MUTE" will display on the screen.
2. Press **MUTE** again to cancel the mute.

MENU ADJUSTMENT

CHANNEL ADJUSTMENT

Press **TV MENU** to bring up the TV menu screen.

Press **◀ / ▶** to select "Channel" and press **▼** to enter into the items below "Channel".

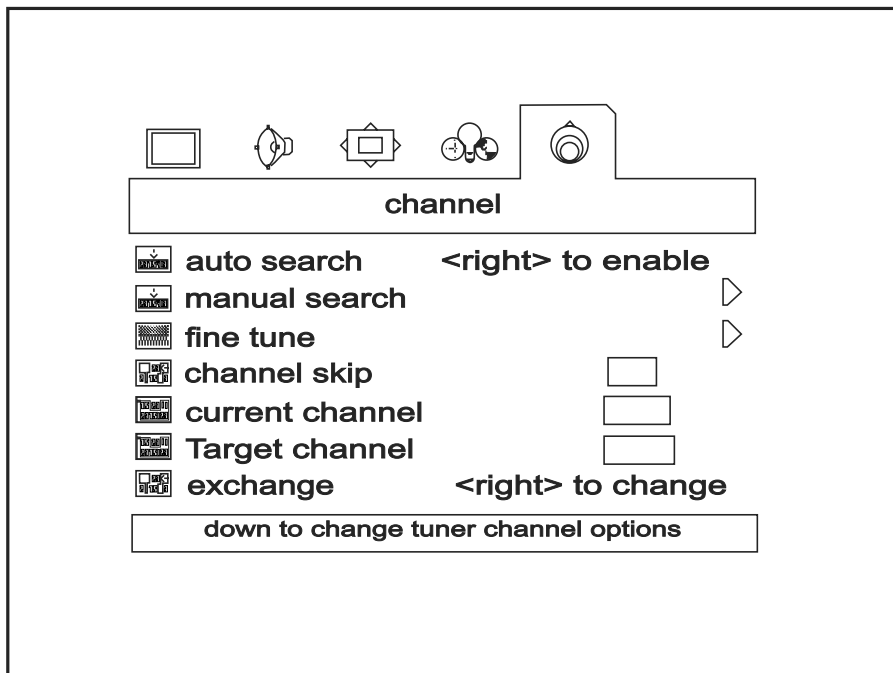

Automatic channel search

Channel auto search finds and memorizes all channels viewable in your area. Select one between AIR and CABLE before this operation.

1. Press **TV MENU** to bring up the TV menu screen.
2. Press **◀ / ▶** to select "Channel".
3. Press **▲ / ▼** to select "Auto Search".
4. Press **◀ / ▶** to begin the searching. Wait until the searching ends.

NOTE: The illustrations and on-screen displays in this manual are for explanation purposes and may vary from the actual operations.

Manual Search

1. Press **TV MENU** to bring up the TV menu screen.
2. Press **◀ / ▶** to select "Channel".
3. Press **▲ / ▼** to move to "Manual Search".
4. Press **▶** to enter "Manual Search" screen.
5. Press **◀ / ▶** to enable search; press **OK** to return; press **TV MENU** to exit.

MENU ADJUSTMENT

CHANNEL ADJUSTMENT (CONTINUED)

Current channel number selection

1. Press **TV MENU** to bring up the TV menu screen.
2. Press **◀ / ▶** to select "Channel".
3. Press **▲ / ▼** to select "Current Channel".
4. Press **◀ / ▶** to select a current channel number you want.

Fine tuning

If you are unable to get a good picture or sound because of a poor broadcast signal, you may adjust the channel by Fine Tuning.

1. Press **TV MENU** to bring up the TV menu screen.
2. Press **◀ / ▶** to select "Channel".
3. Press **▲ / ▼** to select "Fine Tune".
4. Press **▶** to enter "Fine Tune" screen.
5. Press **◀ / ▶** to tune for a better picture and sound; press **OK** to return; press **TV MENU** to exit.

Target channel

1. Press **TV MENU** to bring up the TV menu screen.
2. Press **◀ / ▶** to select "Channel".
3. Press **▲ / ▼** to select "Target Channel".
4. Press **◀ / ▶** to select a target channel number.

Channel skip

1. Press **TV MENU** to bring up the TV menu screen.
2. Press **◀ / ▶** to select "Channel".
3. Press **▲ / ▼** to move to "Channel Skip".
4. Press **◀ / ▶** to select between "On" and "Off".

Exchange

1. Press **TV MENU** to bring up the TV menu screen.
2. Press **◀ / ▶** to select "Channel".
3. Press **▲ / ▼** to move to "Exchange".
4. Press **◀ / ▶** to change.

MENU ADJUSTMENT

PICTURE ADJUSTMENT

Press **TV MENU** to bring up the TV menu screen.

Press ◀ / ▶ to select "Picture" and press ▼ to enter into below items.

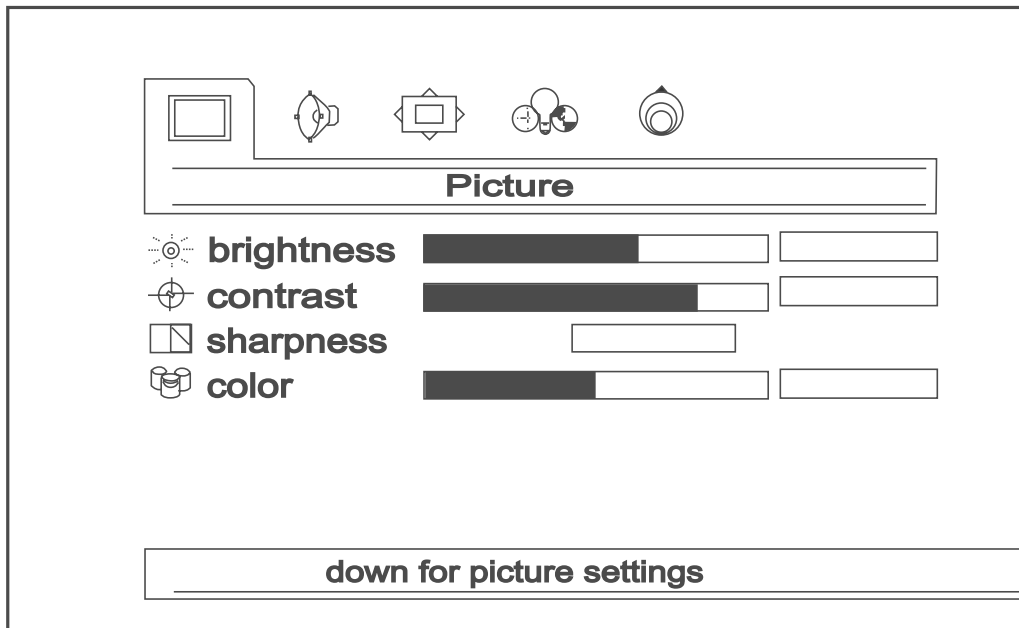

Contrast

1. Press **TV MENU** to bring up the TV menu screen.
2. Press ◀ / ▶ to select "Picture".
3. Press ▲ / ▼ to move to "Contrast".
4. Press ◀ / ▶ to adjust the picture contrast.

Brightness

1. Press **TV MENU** to bring up the TV menu screen.
2. Press ◀ / ▶ to select "Picture".
3. Press ▲ / ▼ to move to "Brightness".
4. Press ◀ / ▶ to adjust the picture brightness.

Color

1. Press **TV MENU** to bring up the TV menu screen.
2. Press ◀ / ▶ to select "Picture".
3. Press ▲ / ▼ to move to "Color".
4. Press ◀ / ▶ to adjust the picture color.

Sharpness

1. Press **TV MENU** to bring up the TV menu screen.
2. Press ◀ / ▶ to select "Picture".
3. Press ▲ / ▼ to move to "Sharpness".
4. Press ◀ / ▶ to adjust the picture sharpness.

MENU ADJUSTMENT

AUDIO ADJUSTMENT

Press **TV MENU** to bring up the TV menu screen.

Press **◀ / ▶** to select "Audio" and press **▼** to enter into below items.

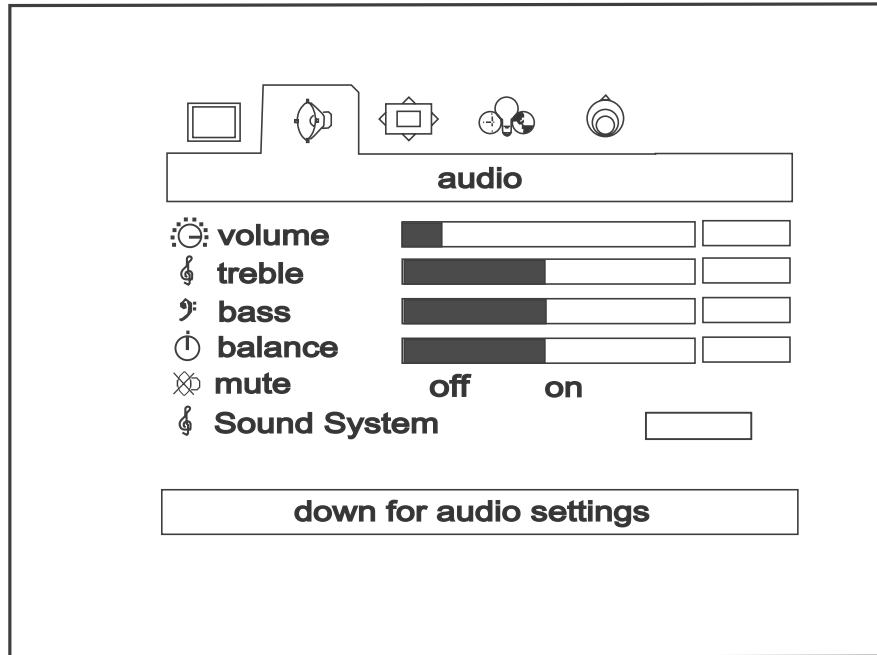

Volume

1. Press **TV MENU** to bring up the TV menu screen.
2. Press **◀ / ▶** to select "Audio".
3. Press **▲ / ▼** to move to "Volume".
4. Press **◀ / ▶** to adjust the volume.

Bass

1. Press **TV MENU** to bring up the TV menu screen.
2. Press **◀ / ▶** to select "Audio".
3. Press **▲ / ▼** to move to "Bass".
4. Press **◀ / ▶** to adjust the bass weaker or stronger.

Treble

To stress high frequency sound

1. Press **TV MENU** to bring up the TV menu screen.
2. Press **◀ / ▶** to select "Audio".
3. Press **▲ / ▼** to move to "Treble".
4. Press **◀ / ▶** to adjust the treble weaker or stronger.

MENU ADJUSTMENT

AUDIO ADJUSTMENT (CONTINUED)

Balance

1. Press **TV MENU** to bring up the TV menu screen.
2. Press ◀ / ▶ to select "Audio".
3. Press ▲ / ▼ to move to "Balance".
4. Press ◀ / ▶ to adjust audio output between left and right speakers.

Mute

This function is to remove the sound.

1. Press **TV MENU** to bring up the TV menu screen.
2. Press ◀ / ▶ to select "Audio".
3. Press ▲ / ▼ to move to "Mute".
4. Press ◀ / ▶ to select "Off" or "On".

Sound System

This function is to select the sound appropriate to your TV program.

1. Press **TV MENU** to bring up the TV menu screen.
2. Press ◀ / ▶ to select "Audio".
3. Press ▲ / ▼ to move to "Sound System".
4. Press ◀ / ▶ to select among DK, I, Auto and BG.

MENU ADJUSTMENT

WINDOW ADJUSTMENT

PC mode input format

	Resolution	V freq. (Hz)	H freq. (KHz)
VGA	640 × 480	60	31.5
	640 × 480	72	37.9
	640 × 480	75	37.5
	640 × 480	85	43.3
	720 × 400	70	31.5
SVGA	800 × 600	60	37.9
	800 × 600	75	46.9
	800 × 600	85	53.7
	800 × 600	72	48.1
XGA	1024 × 768	60	48.4
	1024 × 768	70	56.5
	1024 × 768	75	60.2

In case of inputting the PC signal other than above signals, "OUT OF RANGE" will display.

Setup your PC software...

Even if your actual display-setting screen looks different from the windows below, basic setup methods will be applied in most of the case.

1. First, click on "Setting" on the Windows Start menu. While "Setting" is selected, move the cursor to submenu "Control Panel".



MENU ADJUSTMENT

WINDOW ADJUSTMENT (CONTINUED)

2. When the control panel screen appears, click on "Display" and a display dialog box displays.



3. Navigate to the "Setting" tab on the display dialog box. The correct setting of size (resolution) is "1024 x 768 pixels".

Check the vertical frequency of your PC.



MENU ADJUSTMENT

WINDOW ADJUSTMENT (CONTINUED)

Press **TV MENU** to bring up the TV menu screen.

Press **◀ / ▶** to select "Window" and press **▼** to enter into below items.

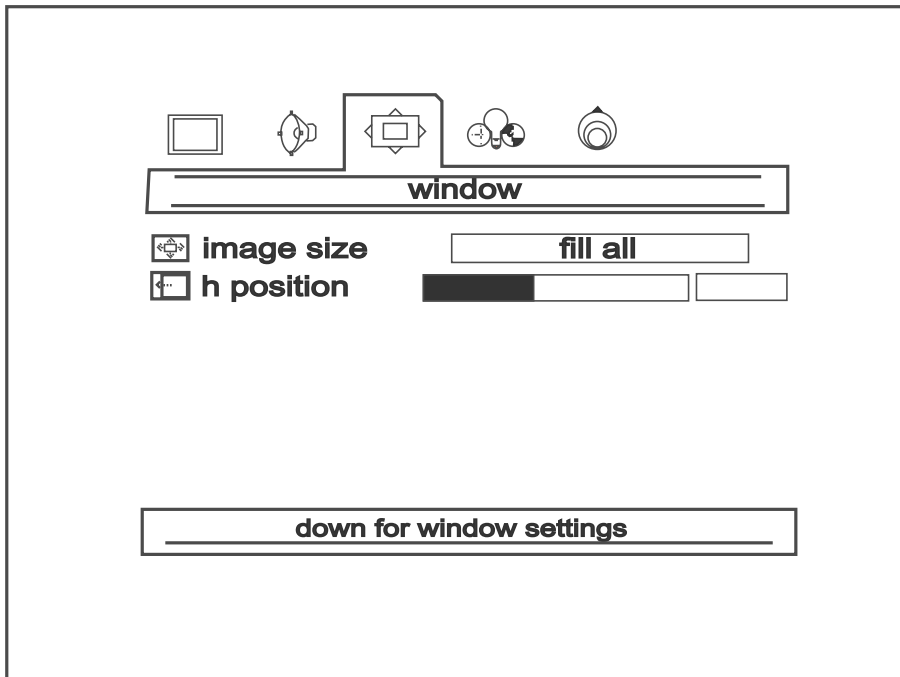

H-Position

1. Press **TV MENU** to bring up the TV menu screen.
2. Press **◀ / ▶** to select "Window".
3. Press **▲ / ▼** to move to "H-Position".
4. Press **◀ / ▶** to adjust the horizontal position of displayed image.



Before adjustment



After adjustment

Image Size

1. Press **TV MENU** to bring up the TV menu screen.
2. Press **◀ / ▶** to select "Window".
3. Press **▲ / ▼** to move to "Image Size".
4. Press **◀ / ▶** to select an image size between: Fill All and Force 4:3.

MENU ADJUSTMENT

OPTIONS ADJUSTMENT

Press **TV MENU** to bring up the TV menu screen.

Press **◀ / ▶** to select "Options" and press **▼** to enter into below items.

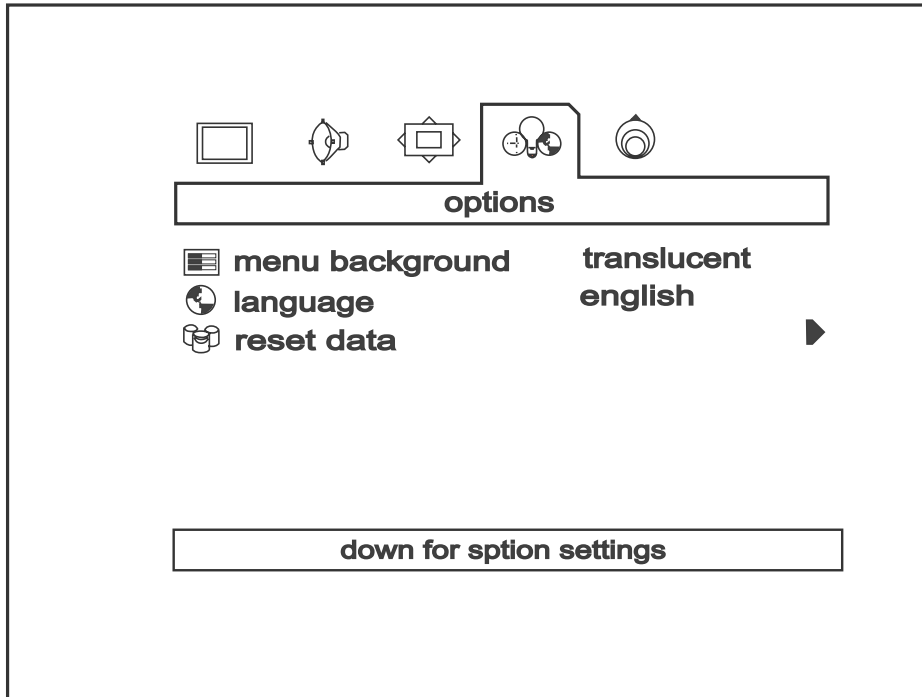

Menu Background

1. Press **TV MENU** to bring up the TV menu screen.
2. Press **◀ / ▶** to select "Options".
3. Press **▲ / ▼** to move to "Menu Background".
4. Press **◀ / ▶** to select the menu background between: Translucent and Opaque.

Menu Language

You can select a language from Function menu as well. Select one between English and Chinese.

1. Press **TV MENU** to bring up the TV menu screen.
2. Press **◀ / ▶** to select "Options".
3. Press **▲ / ▼** to move to "Language".
4. Press **◀ / ▶** to select the language between English and Chinese.

Reset Date

1. Press **TV MENU** to bring up the TV menu screen.
2. Press **◀ / ▶** to select "Options".
3. Press **▲ / ▼** to move to "Reset Data".
4. Press **▶** to reset all settings to factory setting.

TROUBLESHOOTING

Please check the following items before asking for repair service.

Symptom	Check Items
Neither picture nor sound.	<ul style="list-style-type: none"> - Check the contact of sockets is all right. - Check the TV main power is on.
Picture is OK, but no sound.	<ul style="list-style-type: none"> - Check the volume control is set to minimum or mute.
Sound is OK, but no color.	<ul style="list-style-type: none"> - Check the color control and adjust it properly. - Check the programme is in color or in black & white.
The picture is overlapped image.	<ul style="list-style-type: none"> -Check the antenna is installed correctly and if not, adjust the antenna toward the broadcasting station. -Check the "FINE TUNE "is set up correctly and if not, adjust the fine tuning properly.
Picture has "snow noise ".	<ul style="list-style-type: none"> - Check the antenna or its connection is correct and if not, correct the antenna fault or connection cable fault. - Check if car traffic or neon sign disturbs the sound effect.
Stripes on picture.	<ul style="list-style-type: none"> - Check the susceptible interference by other electronic devices such as radio and television and keep magnetic or electronic devices away from the TV.
Bad stereo or SAP sound.	<ul style="list-style-type: none"> - Long distance from the station or other radio waves can generate bad sound. Reception. If so, change the mode to Mono.
Remote control does not work.	<ul style="list-style-type: none"> - Check if the batteries in the Remote control die. - Check if any object between IR sensor of the TV and the Remote control does not obstruct.
"Out Of Range" appears on the screen.	<ul style="list-style-type: none"> - Check the resolution and frequency of your PC. Then, adjust them to optimum condition for LCD TV: 1024X768 and 60Hz. - Refer to the table of PC mode input format indicated on page 21. (Not being registered resolution and frequency on the table won't be displayed.)
"No Signal" appears on the screen.	<ul style="list-style-type: none"> -Ensure that the signal cable is firmly connected to PC and TV.
Image is not clear.	<ul style="list-style-type: none"> -Adjust the PHASE control. (Refer to the PC ADJUSTMENT.)
Image is not centered.	<ul style="list-style-type: none"> - Adjust the H-POSITION, H-SIZE and V-POSITION Control. (Refer to the PC ADJUSTMENT.)

SPECIFICATIONS

LCD	PANEL	17" WIDE TFT LCD
	RESOLUTION	1280 X RGB X 768 (WXGA)
	ACTIVE AREA (mm)	372.5 X 223.5
	VIEWING ANGLE (i,U/D/L/R)	45/45/60/60
	BRIGHTNESS (cd/m2)	450
DIMENSION	WITH STAND (mm)	532 X 352 X 185
	WITHOUT STAND (mm)	532 X 297 X 58
WEIGHT (WITHOUT ACCESSORIES)		13.7lbs (6.6kg)
TV-FUNCTION	TV STANDARD	NTSC/PAL
	TUNING SYSTEM	ELECTRIC TUNING SYSTEM
	STEREO	MTS + SAP
	CATV	125 CHANNELS
INPUT POWER		DC12V, AC100-240V~, 50/60Hz
SOUND OUTPUT		2W + 2W
POWER CONSUMPTION		44W
TERMINALS	AV IN	VIDEO, S-VIDEO, AUDIO L&R
	COMPONENT	Y, Pb (Cb), Pr (Cr)
	MONITOR OUT	VIDEO OUT
	HEADPHONE	3.5¿ STEREO MINI-JACK
	PC IN	D-SUB 15PIN RGB IN
	ANTENNA IN	F-TYPE

TABLE OF CONTENTS (FOR DVD PLAYER)

BASIC OPERATIONS	27-31
• PLAY DISCS	27
• PAUSE	27
• OSD	27-30
• VOLUME CONTROL	30
• DVD MENU PLAY	30
• SELECT WITH NUMBER BUTTONS	31
PLAY DISCS IN VARIOUS WAYS	31-37
• AUDIO MODE	31-32
• MUTE	32
• FAST PLAY	32
• SLOW PLAY	33
• REPEAT PLAY	33-34
• SELECT SUBTITLES	34
• ANGLES SELECT	35
• TIME SEARCH	35-36
• PROGRAM PLAY	36-37
• SHUFFLE (RANDOM) PLAY	37
MENU SETTING	38-43
• GENERAL SETUP	39-40
• AUDIO SETUP	40-42
• VIDEO SETUP	42
• PASSWORD SETUP	42
• PREFERENCES	43
MP3 OPERATIONS	43
KODAK PICTURE CD PLAYBACK	44
TROUBLESHOOTING	45
TECHNICAL SPECIFICATIONS	46

BASIC OPERATIONS

Play Discs



1. Press **POWER** to turn on the unit.
2. Press the **SOURCE** button on the remote control to bring up the AV signal source selection screen and use the **▲/▼** buttons to select "DVD", press the **OK** button to confirm.
3. Insert a disc into the disc slot, with the label side facing to yourself.
4. The unit begins to read the disc.
5. Press **▶** (PLAY) to play the disc.

AFTER STEP 4 IS FINISHED:

- If playing a DVD, the TV screen shows DVD menu or title menu.
 - If playing a CD, press **▶** (PLAY), and the unit plays the disc according to the track numbers.
5. Stop playback.
Press **■**.

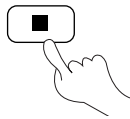

6. Press the **▲** button on the remote control to remove the disc and turn off the unit.
- You have to push "**■**" button twice to stop playback of a DVD disc.

Pause



Press **⏸**

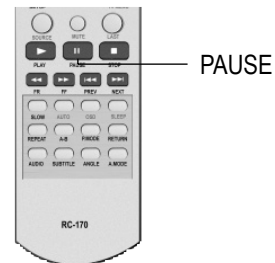

DVD

- To pause playback of a DVD while it is playing, press **⏸**. The unit enters step play status. Each time you press **⏸**, the picture advances one frame.

CD

- Press **⏸** to make playback pause.
Press **▶** (PLAY) to resume playback.

OSD

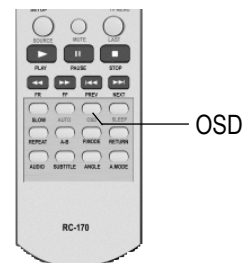

The On-Screen Display (OSD) contains many playback features. To see the Display, press the **OSD** button on the remote while a disc is playing. The Display appears across the top of the screen. Each feature is illustrated with an icon. Use the **◀** or **▶** buttons on the remote to move through the different icons in the Display. When an icon is highlighted, use the **▼** or **▲** buttons on the remote to scroll through the choices displayed in the text box under the icons.

BASIC OPERATIONS

Remember, you can only access the Display when you're playing a disc. Also, the Display features are only available if the disc was created with that particular feature (i.e., if you select the Subtitle icon, you won't be able to change the subtitle language unless the author of the disc created the disc with subtitles).

The invalid symbol "⊗" appears on the screen when you press a button that doesn't have any function. If one of the icons is "grayed out", that Display feature isn't available for the disc you're playing. To make the Display disappear from the screen, press **OSD** on the remote.

DVD

DVD discs have the following playback features: Title, Chapter, Audio, Subtitle, Angle and Repeat.

■ Select a Title

Some discs contain more than one title. For example, there might be four movies on one disc (each movie might be considered a title).

Each title is divided into chapters. To select a title:

1. While the disc is playing, press **OSD** on the remote to bring up the Display.
2. If the Title icon on the Display isn't highlighted, use the ◀ or ▶ buttons to highlight it.
3. Press the ▲ or ▼ buttons to go to the previous or next title.

Note: Some discs only have one title.

■ Select a Chapter

Because DVD discs use digital technology, a title can be divided into individual chapters (similar to tracks on a CD).

You can skip to a specific chapter by using the Chapter feature in the Display.

1. While the disc is playing, press **OSD** on the remote to bring up the Display.

2. Press the ◀ or ▶ buttons to highlight the Chapter icon.
3. Press the ▲ or ▼ buttons to go to the previous or next chapter.

Notes: The chapter feature won't work if the disc isn't formatted with separate chapters.

You can also advance to the next chapter by pressing ▶▶ on the remote and go to the preceding chapter by pressing ◀◀ on the remote.

■ Changing the Audio Language

If the disc was created with different language tracks (recorded in different languages), you can use the Display to temporarily change the DVD player's Audio Language setting.

1. While the disc is playing, press **OSD** on the remote to bring up the Display.
2. Press the ◀ or ▶ buttons to highlight the Audio icon. The current audio language appears in the text box below the row of icons.
3. Press the ▲ or ▼ buttons to scroll through the audio languages that are available on the disc until the audio language you want to use appears in the text box. Audio will be played in that language.
4. To make the Display disappear, press the **OSD** button on the remote.

Note: The language feature only works if the disc was created with multiple audio tracks. When you choose an audio language from the Display, you only override the audio language setting in the DVD player's main menu temporarily.

The audio language can also be changed through the DVD player menu.

■ Selecting the Subtitle Language

If the disc was created with subtitles, you can use the Display to change the Subtitle language.

BASIC OPERATIONS

1. When the disc is playing, press **[OSD]** on the remote to bring up the Display.
2. Press the ◀ or ▶ buttons to highlight the Subtitle icon.
3. Press the ▲ or ▼ buttons to scroll through the subtitle languages that are available on the disc until the subtitle language you want to use appears in the text box. The subtitles will be shown in that language.
4. To make the Display disappear, press the **[OSD]** button on the remote.

Notes: Changing the subtitle language with the Display will only affect the disc currently being played. When the disc is removed or the player is turned off, the subtitle language will revert to the language setting specified through the DVD player main menu.

The subtitle language can also be changed through the DVD player menu.

■ Changing the Camera Angle

Some discs contain multiple angles of a particular scene or sequence. If the disc only has one angle, this feature won't work. When multiple angles are available, to change the camera angle:

1. When a disc is playing, press **[OSD]** on the remote to bring up the Display.
2. The Angle icon will display the number of angles available. For example, if there are 3 different angles, the icon will read 1 of 3. This means angle 1 is currently being played.
3. Press the ▲ or ▼ buttons to scroll through the angle choices. The angle number displayed in the text window is automatically shown.
4. To make the Display disappear, press the **[OSD]** button on the remote.

■ Using the Repeat Feature

The default mode for the Repeat feature is off. There are three Repeat options:

- All - repeats the disc that is playing
- Title - repeats the title that is playing
- Chapter - repeats the chapter that is playing

To Use Repeat:

1. While a disc is playing, press **[OSD]** on the remote to bring up the Display.
2. Highlight the Repeat icon.
3. Press the ▲ or ▼ buttons to scroll through the Repeat options until the Repeat option you want is displayed in the text box.
4. The selected repeat option will loop repeatedly until you turn Repeat off.

How to Cancel Repeat:

There are three ways to cancel Repeat:

- Press STOP twice.
- Go to Repeat icon in the Display and select Off.
- Eject the disc.

CD

CD discs have the following playback features: Track, L/R, and Repeat.

■ Select a Specific Track

1. While the disc is playing, press **[OSD]** on the remote to bring up the Display.
2. Highlight the Track icon.
3. Press the ▲ or ▼ buttons to scroll through the track numbers.

■ Changing the Audio Channel Output

If you are playing a Stereo CD, you can change the channel output from the player.

1. Press **[OSD]** on the remote to bring up the Display.
2. Highlight the L/R icon on the Display.
3. The audio channel choices appear in the text box. Press the ▲ or ▼ buttons to scroll through the choices: LEFT MONO, RIGHT MONO, MIXED MONO or STEREO. Whatever choice is displayed becomes the active choice.

■ Using the Repeat Feature

The default mode for the Repeat feature is off. There are two Repeat options for CDs:

- All - repeats the disc that is playing
- Track - repeats the track that is playing

BASIC OPERATIONS

To Use Repeat:

1. While a disc is playing, press **OSD** on the remote to bring up the Display.
2. Highlight the Repeat icon.
3. Press the **▲** or **▼** buttons to scroll through the Repeat options until the Repeat option you want is displayed in the text box.
4. The selected repeat option will loop repeatedly until you turn Repeat off.

Volume Control



- Press **VOLUME** on the TV or amplifier to adjust the volume.
- Press **VOLUME** on the remote control.

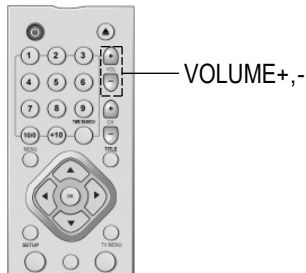

1. Press **+** to raise the volume.



2. Press **-** to lower the volume.

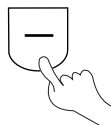

DVD Menu Play

Some DVDs have title menus and chapter menus. Press **▶** (PLAY), the screen shows the menu. Press **▶▶** or **◀◀** to skip to the next or previous page. Select with number buttons or direction buttons.

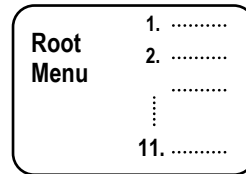

Example: select track 13.

1. Press **▶▶** to enter the next menu.

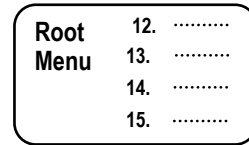

2. Press number buttons to select directly.



You can also select as follows:

1. Press **▼** to select track 13.

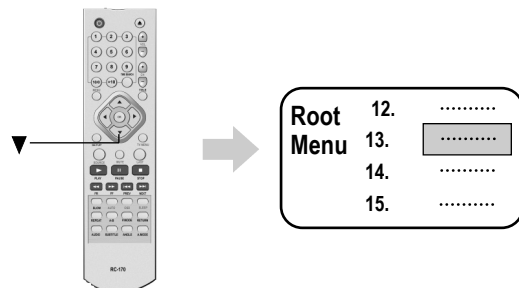

2. Press **▶** (PLAY) to start playing track 13.

Press **TITLE** once to return to the title menu.
Press **MENU** once to return to the root menu.

Select with Number Buttons



Load a disc. Press number buttons to select tracks after the unit finishes reading the disc.

1. If the track number isn't over 10, just push buttons 1-10.
Example: push **8** to select track 8.

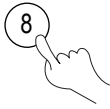

The screen shows:

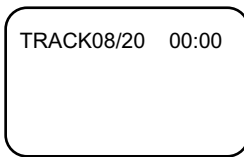

2. If the track number is over 10, press **+10** once and a button between 1-10.
Example: if you select track 12, press **+10** once and button **2**.



The screen shows:

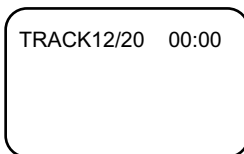

Audio Mode

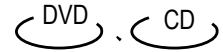

- You may select a language from a multi-language DVD.
- You may select the right channel, left channel, or stereo options from a multi-channel CD.

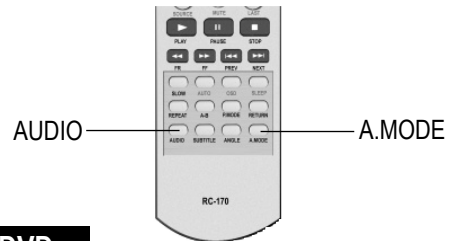

DVD

- To select a language, press **AUDIO**.
The screen will show the following in order:

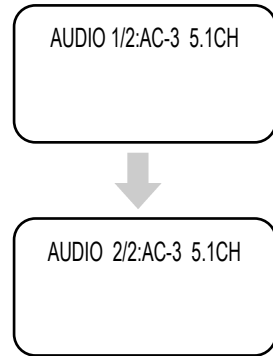

Different discs may differ in languages available.

- To select audio channel option, press **A.MODE**, the screen shows the following in order:

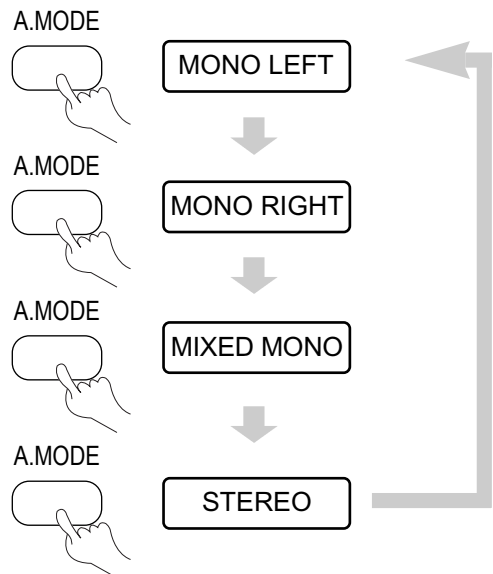

PLAY DISCS IN VARIOUS WAYS

CD

To select audio channel option when for CD playback, press **A.MODE**. The screen will show the following in order:

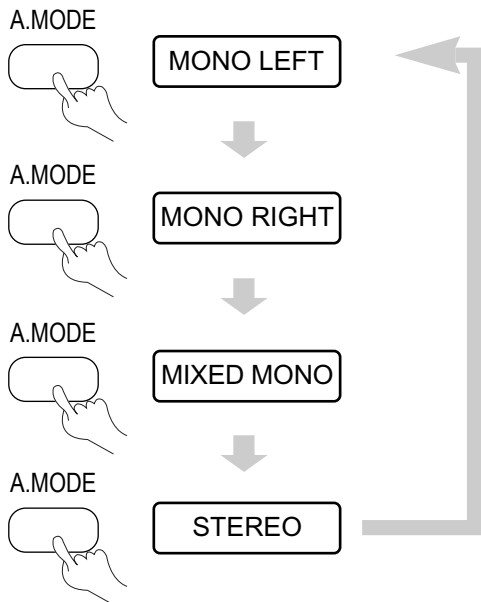

You may select one mode.

Notes:

- Different discs differ in languages available.

Mute DVD, CD

When playing a disc, this function removes the sound.

1. TO REMOVE SOUND

Press **MUTE**, the screen shows "MUTE".

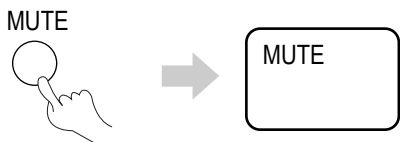

2. TO RESUME SOUND

Press **MUTE** again, the screen shows "MUTE OFF".

Fast Play



When playing a disc, you can play it in fast-forward or fast-reverse mode to find what you want to view.

DVD OR CD

1. While disc is playing, press **FF** to play in fast-forward mode. Each time you press the button, the screen shows the following in order:

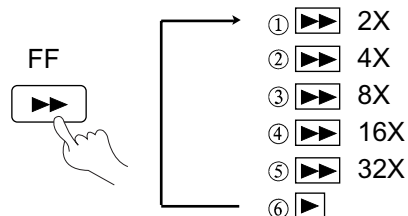

2. While disc is playing, press **FR** to play in fast-reverse mode. Each time you press the button, the screen shows the following in order:

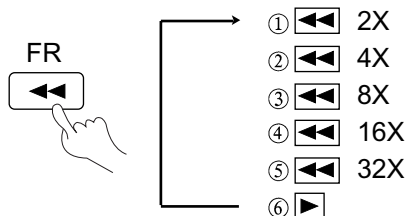

3. Press **▶** (PLAY) to switch to normal play while in fast-forward or fast-reverse playing mode.

PLAY DISCS IN VARIOUS WAYS

Slow Play



Enjoy slow motion by the following the steps below.

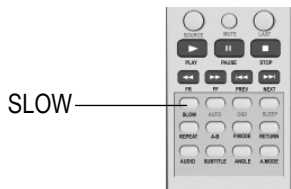

DVD

1. Press **SLOW** to play in slow motion.

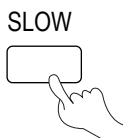

The screen shows the following in order:

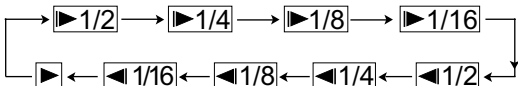

2. Press **▶** (PLAY) to resume play at normal speed.

Repeat Play



This function can be used to repeatedly play a title, chapter, track, disc, or certain parts on a disc.

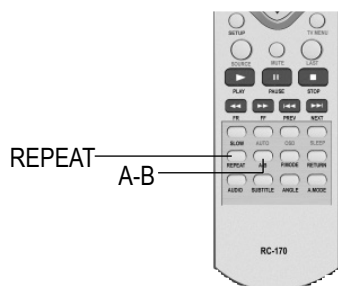

Playing A Disc Repeatedly

DVD

You can repeat a title or chapter.

1. To repeat a chapter:

Press **REPEAT**, the screen will show:

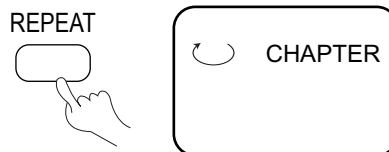

2. To repeat a title:

Press **REPEAT** twice, the screen will show:

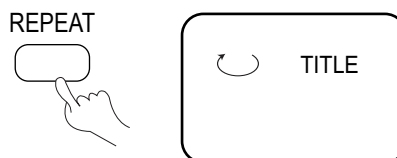

3. To repeat all:

Press **REPEAT** third time, the screen shows "◁ ALL".

4. To remove "REPEAT" function:

Press **REPEAT** until "◁ ALL" disappears.

CD

- You may repeat a track or an entire disc according to the following steps.

1. To repeat a track:

Press **REPEAT**, the screen shows "◁ TRACK".

The unit plays the current track.

PLAY DISCS IN VARIOUS WAYS

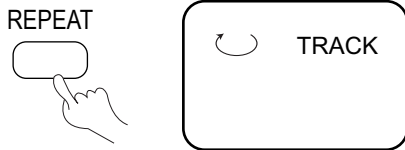

2. To repeat a disc:
Press **REPEAT**, the screen shows " ALL".
The unit plays all the tracks on the disc.

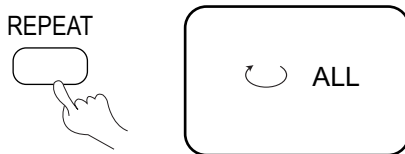

3. To remove "REPEAT" function:
Press **REPEAT** till " ALL" disappears.

Repeat Some Parts

You can designate certain portions of disc to play repeatedly by pressing **A-B** when playing a disc.

DVD OR CD

1. To set a starting point A: press **A-B** where you wish to begin.

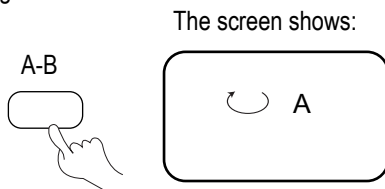

2. To set an end point B: press **A-B** where you wish to end.

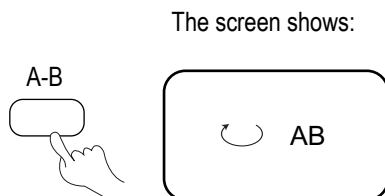

The unit will then play from A to B.

3. To resume normal play, press **A-B** again until " AB" disappears.

Select Subtitles



This operation works only with discs with multiple subtitle languages recorded.

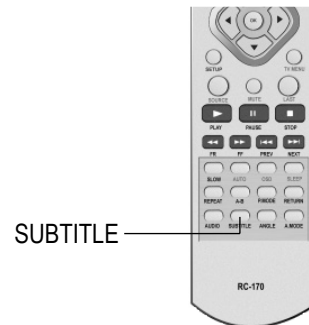

DVD

1. Press **SUBTITLE** repeatedly until the desired language is selected.

The screen shows:

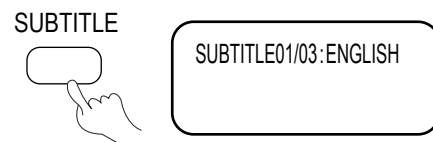

2. Remove the subtitle.

Press **SUBTITLE** until the screen shows "TURN OFF SUBTITLE".

Notes:

- For some discs, subtitles cannot be removed.
- Different discs differ in the language of subtitles.
- If the subtitles of discs cannot be selected, the screen shows " " when you press **SUBTITLE**.

PLAY DISCS IN VARIOUS WAYS

Angles Select



Some discs have images with different viewing angles, you may select among them. For example, when you watch a running train, you may watch it from the front, the left window or the right window without stopping it.

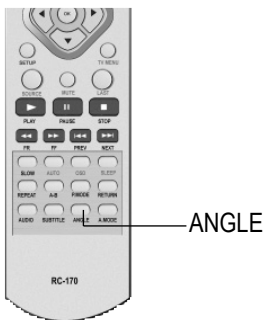

Example:

A DVD has four viewing angles at your option.

1. Press **ANGLE** to select ANGLE1.

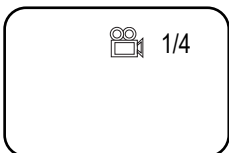

2. Press **ANGLE** to select other angles, the screen shows respectively:

- 2/4 (select ANGLE2)
- 3/4 (select ANGLE3)
- 4/4 (select ANGLE4)

3. To resume normal playback, press **ANGLE** to select original angle.

Time Search

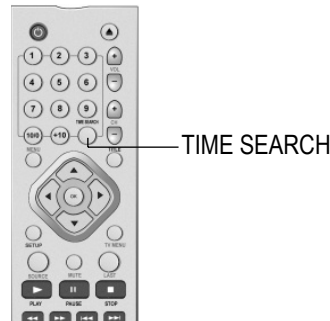

Time Search

You may directly enter a time, title or chapter number to quickly search the disc. The unit will play from that point.

DVD

1. Search a title or a chapter.

Example: Search chapter 2 in title 6.

- Press **TIME SEARCH**, the screen shows:

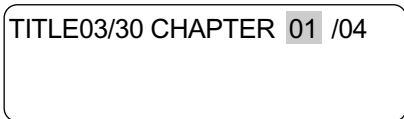

- Press the direction button and move the cursor to illuminate the title number.

The screen shows:

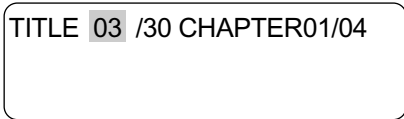

- Press button **6** to select title 6, the screen shows:

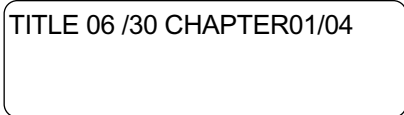

- Repeat the steps above, select chapter 2 in title 6.

PLAY DISCS IN VARIOUS WAYS

2. Time Search.

- Press **TIME SEARCH** until the screen shows:

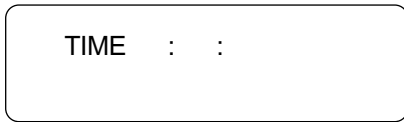

- Press number buttons to enter hour, minute and second.

Example: Enter **1**, **0**, **2**, **3**, **8**

After setting, the unit will play the disc from 1:02:38.

CD

To jump to a specific time, use **TIME SEARCH** to set the time for the desired location.

Example: Play from 00:01:38 of track 6.

- Press button **6** to select track 6.

The screen shows:

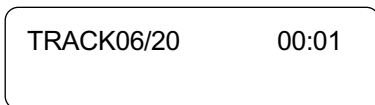

- Press **TIME SEARCH**, the screen shows:

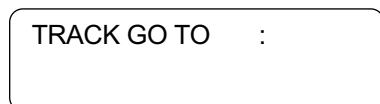

- Press button **0**, **1**, **3**, **8** to enter the time. The screen shows:

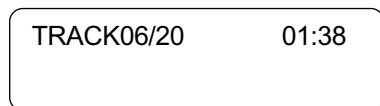

- The unit plays according to entered time and track, for example from 00:01:38 of track 6.
- Press **10/0** to enter 0.

Note: CD discs have three options in time search function:

- You can enter the elapsed time of a disc to play.
- You can enter the elapsed time of a track to play.
- You can go to a track you want play by entering the track number. (Similar to title and chapter search for DVD.)

Program Play



P.MODE

To use the program playback feature, you must enter the order in which you want the titles (and chapters) on the DVD or the tracks on the CD to play by creating a program.

DVD

- Press **P.MODE** until the screen shows:

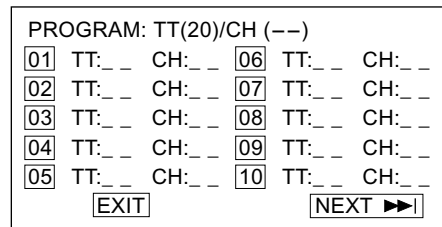

- Use the number buttons on the remote to enter the title (and chapter) you want to play first. The title (and chapter) number you entered appears in the box. For example: Enter Chapter 1 in Title 8, the screen shows:

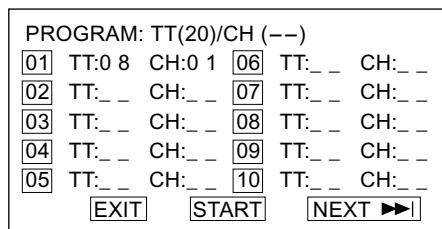

- The cursor jumps to the next spot in the program list section. Make sure the box is highlighted and enter your next track.
- Continue adding title (and chapter) until your program is complete. You can play your program by highlighting **START** and press **PLAY**.
- Note: If you want to program more than 10 titles (and chapters), highlight **NEXT** and press **PLAY** to go to the next page. Proceed to program 11-20 in the same way titles 1-10 were programmed.
- To remove program playback, press the **STOP** button twice during the program play.

PLAY DISCS IN VARIOUS WAYS

CD

1. Press **P.MODE** until the screen shows:

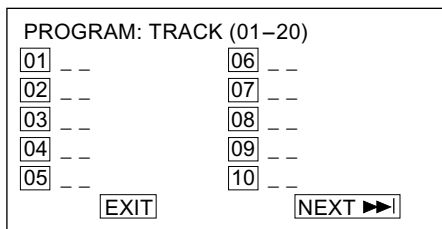

2. Use the number buttons on the remote to enter the track number you want to play first. The track number entered appears in the box. The example: To program track 8 of a CD to play first, enter 8, and the screen shows:

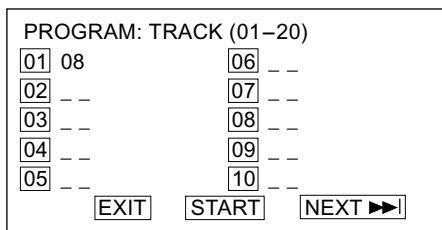

3. The cursor jumps to the next spot in the program list section. Make sure the box is highlighted and enter your next track.
 4. Continue adding tracks until your program is complete. You can play your program by highlighting START and press **PLAY**.

Note: If you want to program more than 10 tracks, highlight NEXT and press **PLAY** to go to next page. Program 11-20 in the same way 1-10 were programmed.

5. To remove program playback, press the **STOP** button during the program play.

Shuffle (Random) Play



The unit can play DVD chapters or audio tracks in random order.

The order is different each time.

1. Press **P.MODE** to select shuffle or randomplay mode when a disc is playing.

P.MODE

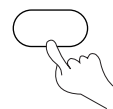

The screen shows:

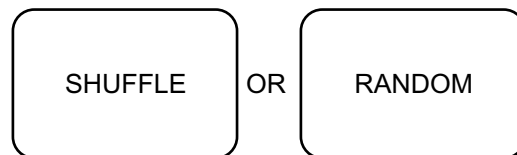

2. Press **▶** (PLAY) to start shuffle or random play.

The unit selects a track to play.

3. Remove shuffle or random play.

- When playing a DVD disc, press **■** twice.
- When playing a CD disc, press **■** twice.

MENU SETTING

According to the recorded information and external equipment, set the following functions for the player to obtain the best playing status.

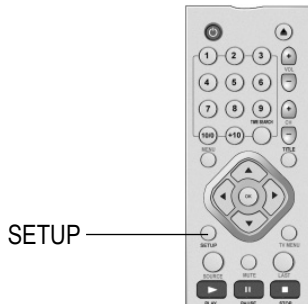

1. Press **SETUP** to set options in the main menu.



The main menu appears on the screen, with icons across the top of the screen, illustrating General Setup, Audio Setup, Video Setup, Preference, Password Setup, and Exit Setup.

The screen shows:

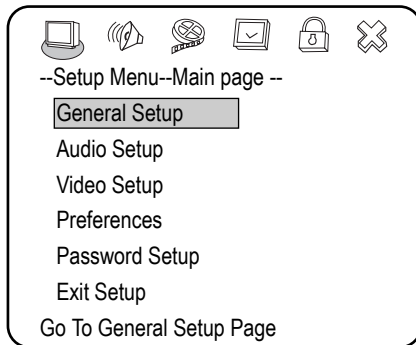

2. Press direction buttons (▼ or ▲) to select and press ► (PLAY) to confirm.

Example: Select "Audio Setup" and do some setup.

- Press direction button ▼ to highlight "Audio Setup", press ► (PLAY) to enter "Audio Setup Page".

The screen shows:

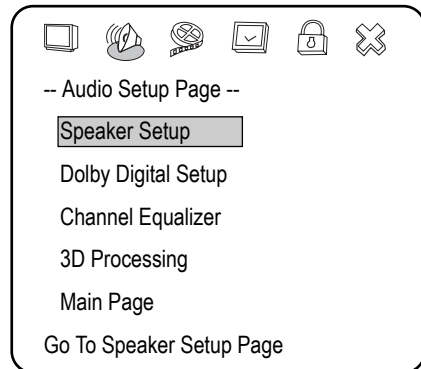

- Press direction buttons (▼ or ▲) to highlight "Dolby Digital Setup", and press ► (PLAY) to enter "Dolby Digital Setup" Page. The screen shows the submenu for your selection.

The screen shows:

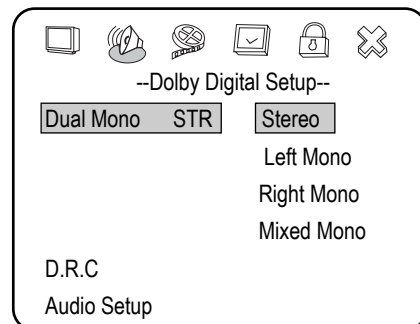

- Press direction buttons ►, ▼ to select "Left Mono".

The screen shows:

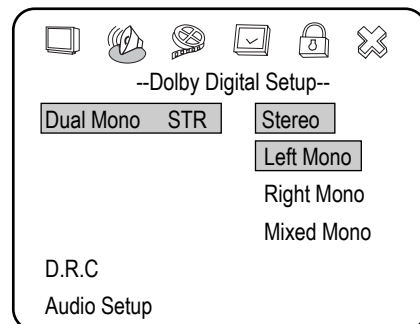

MENU SETTING

- Press ► (PLAY) to confirm your selection. Set "Dual Mono" in "Dolby Digital Setup" to "Left Mono".

The screen shows:

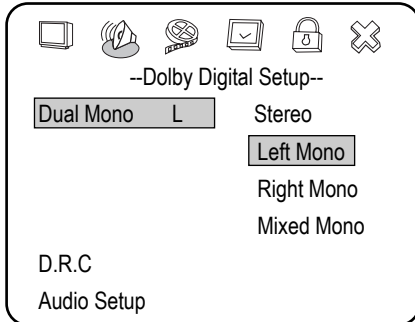

3. Exit setup menu.

- Press the direction button ◀ to exit from "Dual Mono".
- Press the direction button ◀ to exit from "Dolby Digital Setup".
- Press the direction button ▼ to highlight "Main Page" and press ► (PLAY). The screen shows:

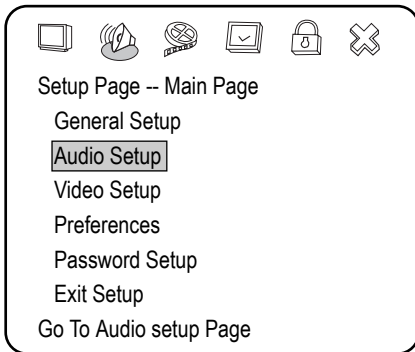

- Press the direction button ▼ to highlight "Exit Setup" and press ► (PLAY) to exit setup menu completely.

NOTE: You can also keep pressing the direction button ◀ until the cursor is moved to the last icon illustrating Exit, then press the ► (PLAY) button to exit setup menu completely.

General Setup

The setting structure is :

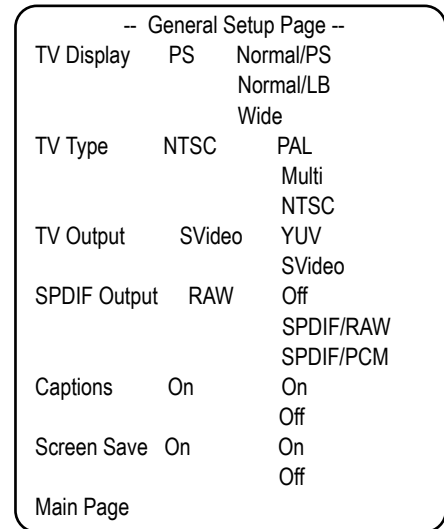

TV DISPLAY

1. NORMAL/PS

This is selected when the unit is connected to a normal TV.

Wide-screen images are shown on the screen, but with some parts cut automatically.

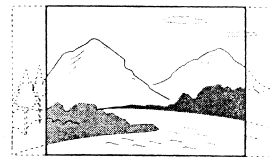

MENU SETTING

2. NORMAL/LB

This is selected when the unit is connected to a normal TV. Wide-screen images are shown on the screen with black bars on the top and bottom of the screen.



3. WIDE

This is selected when the unit is connected to a wide-screen TV.

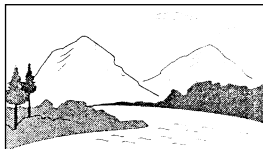

■ TV TYPE

You may select according to the color system of the TV to be connected.

- Select "MULTI" for a multi-system TV.
- Select "NTSC" for a NTSC TV.
- Select "PAL" for a PAL TV.

■ TV OUTPUT

1. YUV

Some TVs or monitors are equipped with component video inputs. Connecting to these inputs allows you to enjoy higher quality picture playback. In some TVs or monitors, the color levels of the playback picture may be reduced slightly or the tint may change. If this happens, adjust the TV or monitor for optimum performance.

2. S-VIDEO

When you select this, you should connect with S-VIDEO.

■ SPDIF OUTPUT

- SPDIF OFF: No signal output is from digital port.
- SPDIF/RAW: Select this when the DVD player is connected with a digital amplifier through digital port. When a Dolby Digital disc or MPEG disc are played, the digital output will be optional. The power amplifier to be connected must have Dolby Digital and MPEG decoding.
- SPDIF/PCM: Select this when the DVD player is connected with a 2-channel digital stereo amplifier. When a Dolby Digital or MPEG disc is played, the digital port will output in PCM 2-channel format.

■ CAPTIONS

- ON
Subtitles are shown.
- OFF
Subtitles are hidden.

■ SCREEN SAVER

The screen saver image appears when the unit stops or the image is frozen for a few minutes. The screen saver prevents damage to the TV screen.

- ON: Start the screen saver.
- OFF: Remove the screen saver.

Audio Setup

The setting structure is:

-- Audio Setup Page --
Speaker Setup
Dolby Digital Setup
Channel Equalizer
3D Processing
Main Page

MENU SETTING

■ SPEAKER SETUP

The setting structure is:

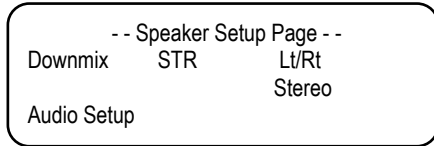

• Lt/Rt

A disc recorded multi channel soundtrack, the output signal will be incorporated to left and right channel.

• STEREO

A disc recorded multi channel soundtrack, the output signal will be incorporated to stereo.

■ DOLBY DIGITAL SETUP

The setting structure is:

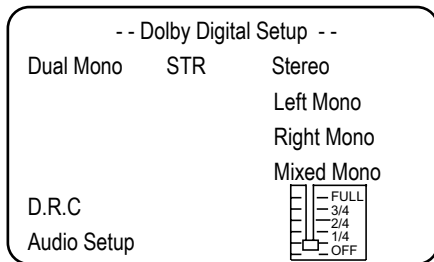

• DUAL MONO

This is the output mode of the L and R signals of the set audio output. If it is set to "MIXED MONO", the function only works when the DVD being played is 5.1-channel.

• D.R.C

This is selected to adjust linear compression rate to obtain the different compression results of the signals.

■ EQUALIZER

This will help you to select graphic equalizer patterns according to the genre of the music being played, and adjust the equalizer.

The setting structure is:

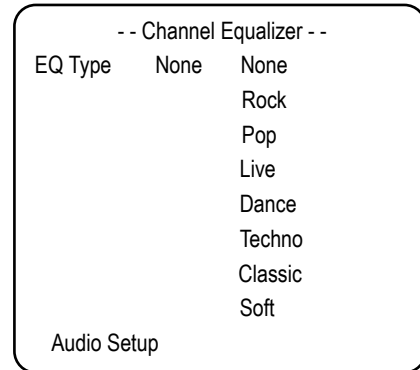

• EQ TYPE

You can select music category by pressing the direction buttons and confirm by pressing the **PLAY** button.

MENU SETTING

3D PROCESSING

The setting structure is:

```

-- 3D Processing Page --
V SURR      Off  On
              Off
Reverb Mode  Off  Off
              Concert
              Living Room
              Hall
              Bathroom
              Cave
              Arena
              Church
Audio Setup
    
```

• V SURR

Use to turn the above function off.

• REVERB MODE

Use to select a Reverb Mode which you want.

Video Setup

The setting structure is:

```

-- Video Setup Page --
Sharpness    High  High
              Medium
              Low
Brightness    00
Contrast      00
Main Page
    
```

SHARPNESS

Use to select the sharpness level.

• HIGH

The sharpness level is highest.

• MEDIUM

The sharpness level is medium.

• LOW

The sharpness level is lowest.

BRIGHTNESS

You can use the ► or ◀ button to adjust the brightness.

CONTRAST

You can use the ► or ◀ button to adjust the contrast.

Password Setup

The setting structure is :

```

-- Password Setup Page --
PW Mode      Off  On
              Off
Password      Change
Main Page
    
```

PASSWORD MODE

- ON: The password function is on and "PARENTAL" is dim and cannot be selected.
- OFF: The password is locked, "PARENTAL" can be selected.

PASSWORD CHANGE

Select this to adapt the code, the screen shows:

```

Old Password   
New Password   
Confirm PWD    

    
```

Enter a password according to the screen.

Note: The password is automatically factory set to 99999.

Preferences

The setting structure is :

-- Preference Page --

Audio	ENG	English	French	Spanish	Chinese	Japanese
Subtitle	ENG	English	French	Spanish	Chinese	Japanese
Disc Menu	ENG	English	French	Spanish	Chinese	Japanese
Parental	08	1 G	2	3 PG	4 PG 13	5 PGR
		6 R	7 NC17	8 ADULT		
Default		Reset				
Main Page						

■ LANGUAGE SELECTION

If a language mentioned above is recorded on the disc, you can select sound, subtitles or disc menu languages. If not, the language recorded on the disc is shown.

■ PARENTAL LOCK

When playing a disc with parental lock function, you may select an age control grade according to the rating your desire.

Example: If "PG" is selected, you cannot play DVD video discs rated higher than the PG grade.

■ DEFAULT >> RESET

Each function setting returns to the initial status in the factory if you select this option.

Note:

- "PREFERENCES" can only be selected when password is OFF when the unit is in stop mode.

■ SELECT TRACKS WITH NUMBER BUTTONS

1. Insert a disc, the unit will search disc information. The TV screen displays main menu.

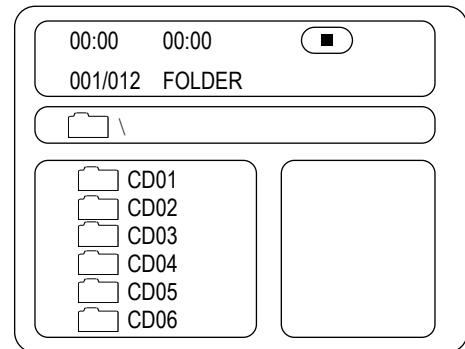

2. Press direction key ▼ to select song folder. Press ► (PLAY) to confirm selection. Example: Select MP3-02, the TV screen displays.

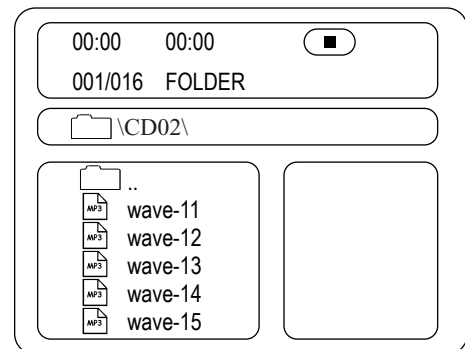

3. Press direction buttons to select a song. Press ► (PLAY) button to start playback.
4. Press ▲ or ▼ button to select other tracks in stop mode.
5. In stop mode, select the folder icon (UP DIR 1) on the left side, then press ► (PLAY) button to return to the main menu.
6. Press ►▶ or ◀◄ to play previous or next songs.

■ OTHER FUNCTIONS

During playback of MP3 discs, the unit features mute, volume control, and repeat play. Operations are the same as CD.

KODAK PICTURE CD PLAYBACK

A Kodak Picture CD has the size and shape of a regular CD. You can order a KODAK Picture CD simply by checking the box on the photofinishing envelope when you drop off a roll of film (35 mm or Advanced Photo System (APS) color print film) at the time of processing in photo processing outlet displaying "Kodak Picture CD" sign. When your order is returned, you receive your prints, negatives, and your full roll of pictures safely stored on your KODAK Picture CD. Each KODAK Picture CD brings you the tools to enhance, share and manage your pictures on your computer.

Now, you can playback Kodak Picture CDs on XXX DVD players and view your pictures on your TV in the comfort of your living room.

Playing back your Kodak Picture CD

The new feature enables the decoding of JPEG files from a Kodak Picture CD disk.

Playback modes

Normal

When a Kodak Picture CD is inserted on a player an automatic slide show is launched. Each picture in the Kodak Picture CD will be displayed consecutively in a slide-show fashion and will be scaled to fit in the TV screen. Twelve slideshow transition modes are provided, use "PLAY MODE" key to select. Select transition mode prior to start of slideshow if one mode is desired for the entire show.

Mode 0: no special transition effect (by default)	Mode 8: wipe from right bottom to left top
Mode 1: wipe from top to bottom	Mode 9: wipe from center to top/bottom
Mode 2: wipe from bottom to top	Mode 10: wipe from center to left/right
Mode 3: wipe from left to right	Mode 11: wipe from top/bottom to center
Mode 4: wipe from right to left	Mode 12: wipe from left/right to center
Mode 5: wipe from left top to right bottom	Mode 13: horizontal blinds
Mode 6: wipe from right top to left bottom	Mode 14: vertical blind
Mode 7: wipe from left bottom to right top	Mode 15: wipe from edge to center
	Mode 16: random

Customer can set transition effects for each picture in a slideshow by using the "PLAY MODE" functions while viewing a slideshow. The last transition mode selected will be used in any future slideshows.

To display an image indefinitely, press the PAUSE key. To view the Next or Previous picture press NEXT or PREVIOUS keys. To resume the slideshow press the PLAY key.

Image Rotation

There are four modes to rotate a picture: "Invert", "Mirror", "Left", and "Right". These operations are allowed only when a picture is being displayed normally and will be cancelled automatically when a new picture is displayed. The arrow key is used to select the different rotation modes:

Up ▲	-Invert/Normal
Down ▼	-Mirror/Normal
Left ◀	-Turn left
Right ▶	-Turn right

Digest

The "MENU" or "STOP" key is used to display thumbnail size pictures. After it is enabled, up to 12 scaled-down thumbnail pictures will be displayed on the screen. The "NEXT" and "PREV" keys can be used to display the next/prev nine pictures in the the Kodak Picture CD.

You can select any of the nine displayed thumbnails by using the Arrow Keys and pressing the "PLAY" key. The thumbnail will be enlarged to fit the TV screen and the slide show will start. If you desire to display an image indefinitely, press the PAUSE key. To view the Next or Previous picture press NEXT or PREVIOUS keys. To resume the slideshow press the PLAY key.

IMPORTANT NOTE:

Quality of pictures displayed on the screen is highly dependent on the viewing device.

TROUBLESHOOTING

If you experience the following problems while using the unit, this troubleshooting guide can help you.

No sound

- Check if the unit is connected securely.
- Make sure the TV or amplifier is working properly.
- Make sure the amplifier is set to receive DVD signal output.

No image

- Check if the unit is connected securely.
- Make sure the TV is working properly.
- Make sure the color system is set correctly.

Bad sound quality

- Make sure the audio output mode is set correctly.
- Make sure the audio connection between the unit and amplifier is in place.

Disc cannot be played

- There is no disc in the unit.
- Put the disc on the disc tray properly with the label side up.
- Clean the disc.
- Moisture has condensed in the unit. Remove the disc and leave the unit on for about an hour.

The unit doesn't operate normally

- Disconnect the power plug and insert it into the wall outlet again.

Remote control does not work

- Remove barriers between the remote control and the unit.
- Point the remote control at the remote control sensor of the unit.
- Replace the batteries with new ones.

TECHNICAL SPECIFICATIONS

Laser	Wavelength 650nm	
Video system	NTSC/MULTI/PAL	
Frequency response	20Hz ~ 20KHz \pm 2.5dB	
Signal/noise ratio	\geq 85dB	
Audio distortion + noise	\leq - 80dB (1KHz)	
Channel separation	\geq 85dB (1KHz)	
Dynamic range	\geq 85dB (1KHz)	
Output	Audio out (analog audio)	output level: $2V \pm 10\%$ Load impedance: $10K \Omega$
	Audio out (digital audio)	output level: $0.5Vp-p \pm 20\%$ Load impedance: 75Ω
	Video out	output level: $1Vp-p \pm 20\%$ Load impedance: 75Ω , imbalance, negative polarity
	S-video out	output level: brightness (Y) $1Vp - p \pm 20\%$ chromaticity (C) $0.286Vp-p \pm 20\%$ Load impedance: 75Ω
	YUV out	Y: $700mv \pm 20\%$ Cb/Pb: $535.5mv \pm 20\%$ Cr/Pr: $535mv \pm 20\%$
Power supply	DC12V, AC100~240V , 50/60Hz	
Power Consumption	\leq 20W	

This manual is only for your reference, any change to the design and specifications will not be advised.